



CLEAN ROOM DEVICES, LLC
"WHERE TUBING AND FITTINGS COME TOGETHER"

CRD200SS TUBE EXPANDER

OPERATIONS MANUAL



VERSION 4.3
LAST EDITED 06.17.15
cleanroomdevices.com

Table of Contents

- Table of Contents.....1
- 1.0 General Product & Safety Information.....2
 - 1.1 Product Information
 - 1.2 Safety Information
- 2.0 Installation.....3
 - 2.1 Air Supply
- 3.0 Operation.....3
 - 3.1 Tube Expanding
 - 3.2 Jaw installation and removal
- 4.0 Parts List.....7
- 5.0 Troubleshooting.....8
- 6.0 Maintenance.....8
 - 6.1 Periodic Cleaning (annually)
- 7.0 Safety.....8
- 8.0 Product specifications.....9
- 9.0 Durometer Scale.....9
- 10.0 Warranty.....10
 - 10.1 Warranty
 - 10.2 Warranty Period

1.0 General Product & Safety Information

1.1 Product Information

- The CRD200 SS Tube Expander is designed to expand flexible tubing up to a durometer of Shore A85 (Shore D35), including any non-metallic braided materials.
- The device only works with tubing that has an inside diameter of .040" to 1/2".
- The standard jaw sets are universal and are designed to be used with an inside diameter range of .040" to 1/2". Other jaw sets are available that are optimized for a specific size (see accessories page at www.cleanroomdevices.com or call Clean Room Devices, LLC).
- The device features simple yet reliable tool-less jaw adjustment, which can be made by the operator.
- The device features a calibrate-able pressure gage conveniently mounted for additional process control.

1.2 Safety Information

- The device has a foot pedal actuated air cylinder that actuates the expanding jaws. The unit is not intended to expand anything other than flexible tubing.

WARNING

- **Avoid placing your fingers between the upper jaw block and the air cylinder mounting bracket while operating unit, sufficient pressure exists to cause personal injury.**

2.0 Installation

Ensure all five (5) rubber feet are completely stabilized on your work surface prior to applying air pressure to the unit.

2.1 Air Supply

- Connect a 1/4" air supply hose to the inlet on the pressure regulator. The air supply should be free of moisture and contaminants and provide a minimum of 100 psi.
- The regulator on the unit should be set to 80-120 psi.

3.0 Operation

3.1 Tube Expanding

- Using **Figure 3.1.1**, follow the steps below to achieve proper expanding size.
- To adjust the jaws for the size tubing to be expanded you need to loosen the **Knurled Lock Nut**.
- With the compressed air attached to the expander, actuate the foot pedal which will activate the expander. Keeping the foot pedal down adjust the expander lower jaw to the position you want using the **Thumb Wheel Knob**.
- Turning the **Thumb Wheel** clockwise will increase the jaw expansion size, counter clockwise will decrease the jaw expansion size. This adjustment may require fine tuning depending on your tubing I.D., O.D., durometer and/or material.
- Once you have the expansion size you want tighten the **Lock Nut** to secure the adjustment. Release the foot pedal.
- Place the tube over the ends of both expander jaws and hold firmly in place.
- Actuate the Tube Expander by pressing the foot pedal.
- Once the tube is expanded, release the foot pedal, rotate the tubing 90 degrees on the jaws and actuate the Tube Expander by pressing the foot pedal again.

Note: Several expanding actions may be necessary to effectively expand the end of the tube for the fitting/connector to slide in. Each time you expand the tubing remember to rotate the tubing 90 degrees on the jaws.

- Quickly insert the component or tube connector before the tubing regains its original size.

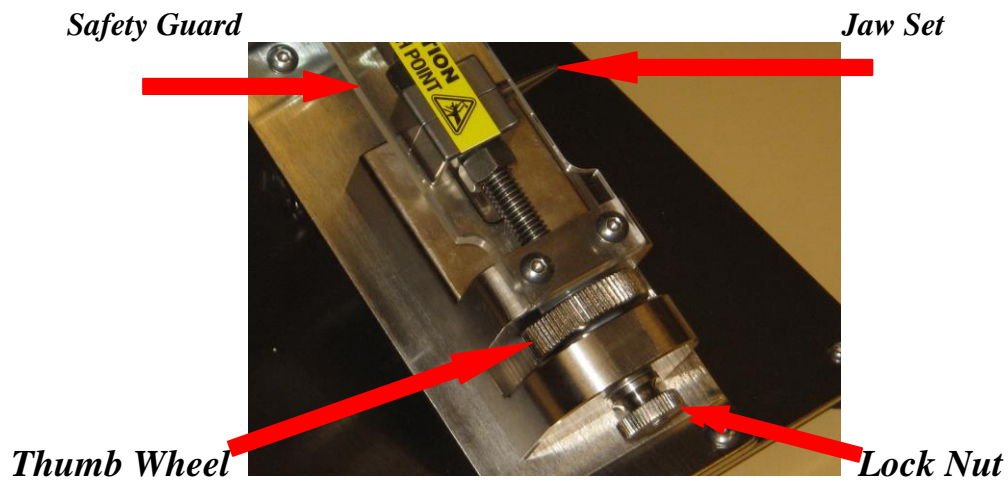

Figure 3.1.1

3.2 Jaw installation and removal

- Tools required are 9/16 open wrench, 11/16 open wrench, 3mm, 4mm and 3/32nd hex wrench
- Remove jaw guard by removing two 5x10mm screws using a 3mm hex wrench.
- Turn the thumb wheel clockwise until the cylinder shaft is fully extended in the jaw block channel to remove force from the cylinder. *Figure 3.2.1*

Cylinder shaft shown fully extended in jaw block channel



Figure 3.2.1

- Using a 11/16 open end wrench break the upper jaw nut loose by turning counter clockwise. *Figure 3.2.2*
- Using a 9/16 open end wrench break the lower jaw nut loose by turning clockwise. *Figure 3.2.3*



Figure 3.2.2

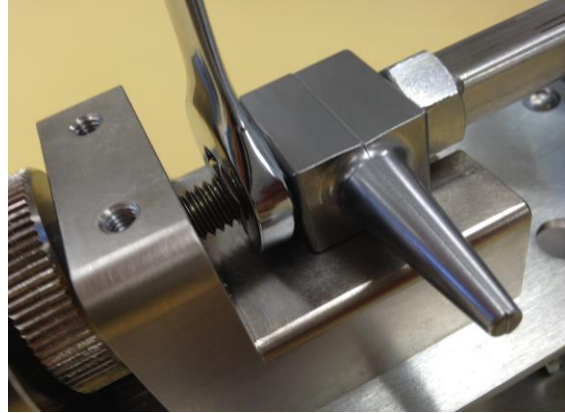

Figure 3.2.3

- Now remove the two 5x12mm screws holding the front cylinder mount bracket using a 4mm hex wrench. *Figure 3.2.4*. Flip the cylinder backwards until it stops. *Figure 3.2.5*

Remove two 5x12mm screws

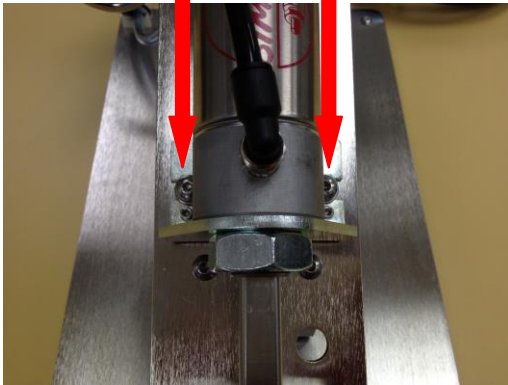

Figure 3.2.4



Figure 3.2.5

- Rotate the upper jaw by hand turning counter clockwise until removed.
- **Important note:** when screwing upper jaw onto cylinder shaft it is important to only screw the jaw 1/2 to 2/3 of the way on. Any farther and the jaw may slip off the jaw block when the cylinder is retracted.

- Remove the ***Knurled lock nut*** and grab threaded rod by hand and rotate threaded rod counter clockwise while holding the lower expander jaw until the jaw is removed. ***Figure 3.2.6***

Rotate rod while holding lower jaw

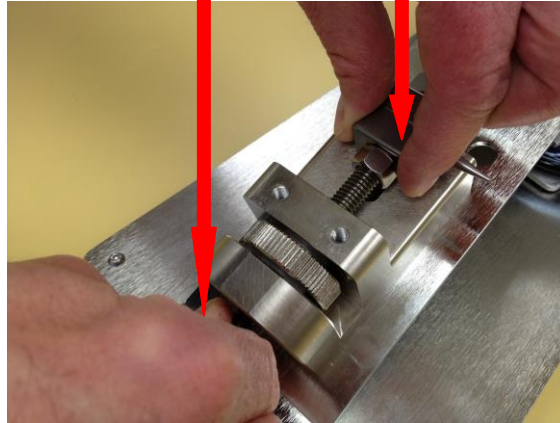

Figure 3.2.6

- Select replacement jaw set and assemble them in the reverse order of previous operations.
- **Note:** If the UP/DOWN alignment of the jaws are incorrect the cylinder shaft won't retract when being cycled. The adjustment of both set screws on the front cylinder mount bracket will need to be adjusted. To make the adjustment you must first loosen the two 5x12mm screws using a 4mm hex wrench (***Figure 3.2.6***) and then by adjusting the two set screws using a 3/32nd hex wrench. ***Figure 3.2.7***. Now tighten the two 5x12mm screws and assure jaw alignment.

5x12 mm screws

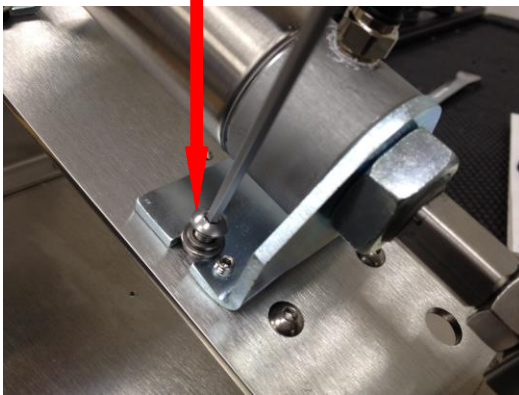

Figure 3.2.6

Set Screw (One per side)



Figure 3.2.7

4.0 Parts List

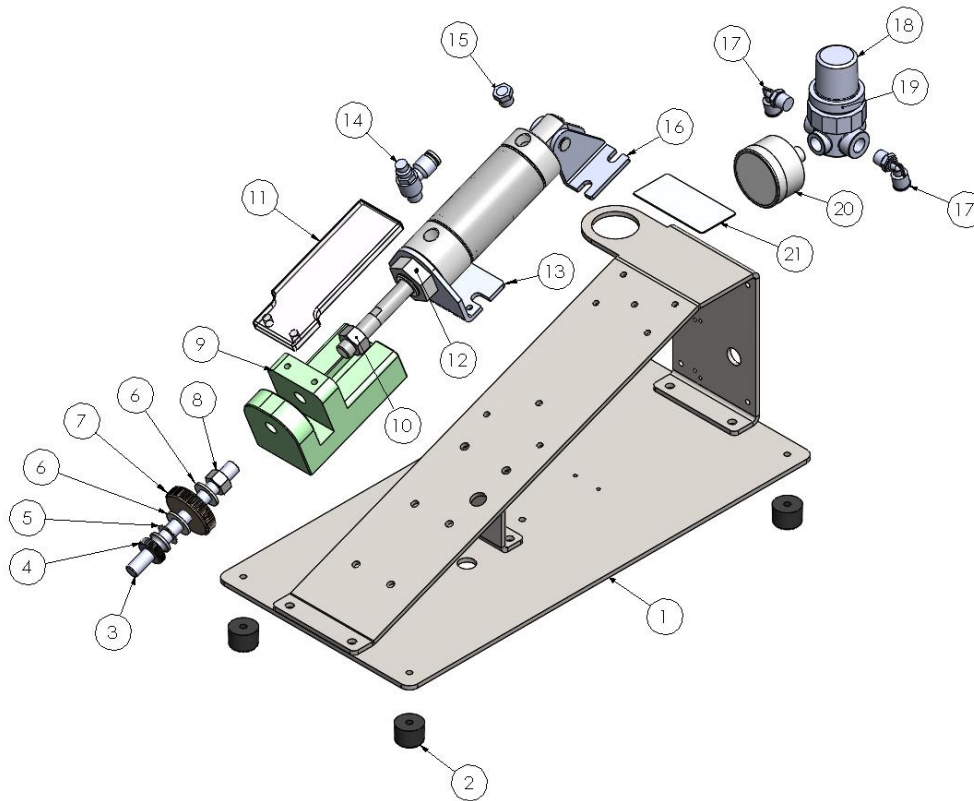

Item	Part Number	Description
1	CD002-002	Base Assembly
2	P00026	Rubber Foot
3	P00057	Threaded Rod
4	CD002-063	Thumb Nut
5	P00056	Steel Flat Washer
6	P00086	Nylon Flat Washer
7	CD002-137	Thumb Knob
8	P00059	3/8-16 Hex Nut
9	CD002-138	Lower Jaw Block
10	P00058	7/16-20 Hex Nut
11	CD002-055	Jaw Guard
12	P00085	3/4-16 Hex Nut
13	CD002-116	Front Cylinder Mounting Bracket
14	P00141	Flow Valve
15	P00022	Muffler
16	P00027	Rear Cylinder Mounting Bracket
17	P00063	90° Elbow Air Fitting
18	P00066	Regulator
19	P00067	Regulator Nut
20	P00280	Pressure Gauge
21	CD001-0027	Nameplate

5.0 Troubleshooting

Operating Error	Action
Unit does not operate.	<ol style="list-style-type: none">1. Check the facility air.2. Check all air hose connections on the unit.
Jaws do not expand.	<ol style="list-style-type: none">1. Ensure there are no obstructions keeping the jaws from expanding.2. Completely depress the foot pedal to actuate.3. Verify that the tubing is within the recommended durometer and size range.
Flexible tubing is splitting/tearing.	<ol style="list-style-type: none">1. Verify that the tubing is within the recommended durometer and size range2. Ensure the lower jaw has been adjusted correctly for the tubing inside diameter (I.D.).3. Verify facility air supply psi or unit pressure adjustment.

6.0 Maintenance

6.1 Periodic Cleaning (annually)

- Wipe down outer surfaces with alcohol, septihol or mild detergents as required.

7.0 Safety

- The jaws are a PINCH POINT, therefore DO NOT OPERATE the Tube Expander without the clear safety guard bolted in place.

8.0 Product Specifications

Unit Weight	12.0 LBS / 5.44 KG
Overall Dimensions	14.5'l x 7.0'w x 7.0'h
Minimum Facility Air Supply	100 PSI
Unit Air Regulator Setting	80-120 PSI

9.0 Durometer Scale

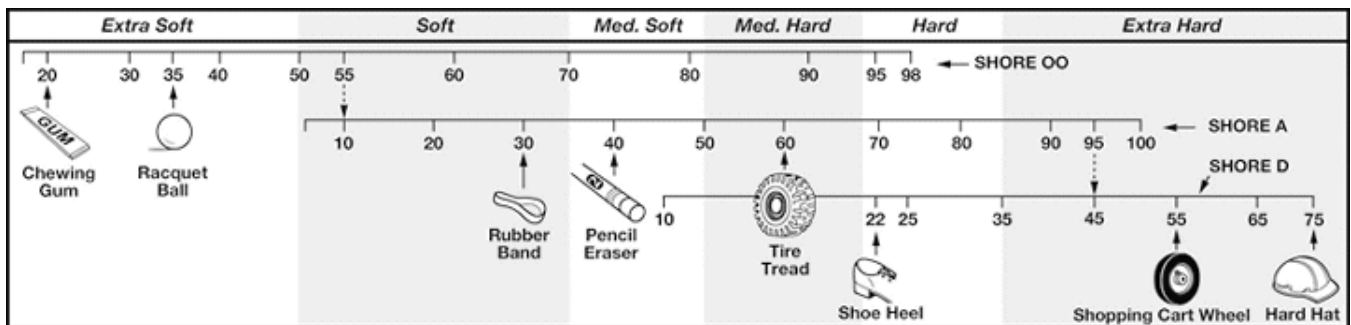

10.0 Warranty

10.1 Warranty

The manufacturer warrants the product manufactured by it, when properly installed, operated, applied and maintained in accordance with the procedures and recommendations outlined in the manufacturer's operation manual, to be free from defects in material or workmanship for a period as specified below, provided such defect is discovered and brought to the manufacturer's attention within the aforesaid warranty period.

The manufacturer will repair or replace any product or part determined to be defective by the manufacturer within the warranty period, provided such defect occurred in the normal service and not as a result of misuse, abuse, neglect or accident. Normal maintenance items requiring routine replacement are not warranted. The warranty covers parts and labor for the warranty period unless otherwise specified. Repair or replacement shall be made at the factory or the installation site, at the sole discretion of the manufacturer. Any service performed on the product by anyone other than the manufacturer must first be authorized by the manufacturer.

Unauthorized service voids the warranty and any resulting charge or subsequent claim will not be paid. Products repaired or replaced under warranty shall be warranted for the unexpired portion of the warranty applying to the original product.

The foregoing is the exclusive remedy of any buyer of the manufacturer's product. The maximum damages liability for the manufacturer is the original purchase price of the product or part.

THE FORGOING WARRANTY IS EXCLUSIVE AND IN LIEU OF ALL OTHER WARRANTIES, WHETHER WRITTEN, ORAL, OR STATUTORY, AND IS EXPRESSLY IN LIEU OF THE IMPLIED WARRANTY OF MERCHANTABILITY AND THE IMPLIED WARRANTY OF FITNESS FOR A PARTICULAR PURPOSE. THE MANUFACTURER SHALL NOT BE LIABLE FOR LOSS OR DAMAGE BY REASON OF STRICT LIABILITY IN TORT OR ITS NEGLIGENCE IN WHATEVER MANNER INCLUDING DESIGN, MANUFACTURE OR INSPECTION OR THE EQUIPMENT OR ITS FAILURE TO DISCOVER, REPORT, REPAIR, OR MODIFY LATENT DEFECTS INHERENT THEREIN.

THE MANUFACTURER, HIS REPRESENTATIVE OR DISTRIBUTOR SHALL NOT BE LIABLE FOR LOSS OF USE OF THE PRODUCT OR OTHER INCIDENTAL OR CONSEQUENTIAL COSTS, EXPENSES, OR DAMAGES INCURRED BY THE BUYER, WHETHER ARISING FROM BREACH OF WARRANTY, NEGLIGENCE OR STRICT LIABILITY IN TORT.

The manufacturer does not warrant any product, part, material, component, or accessory manufactured by others and sold or supplied in connection with the sale or manufacturer's products.

10.2 Warranty Period

Parts and labor for ninety (90) days from the date of shipment from the factory. Freight to the factory on units that the manufacturer requests to be returned shall be paid by the purchaser, all return freight to be paid by the manufacturer; means of transportation to be specified by the manufacturer.

For additional information contact: www.cleanroomdevices.com
Clean Room Devices, LLC
10855 Dover Street,, Suite 100
Westminster, CO 80021
303-438-0853