

 **CLEAN ROOM DEVICES, INC.**

CRD170 MULTI-ANGLE TUBING CUTTER

OPERATIONS MANUAL

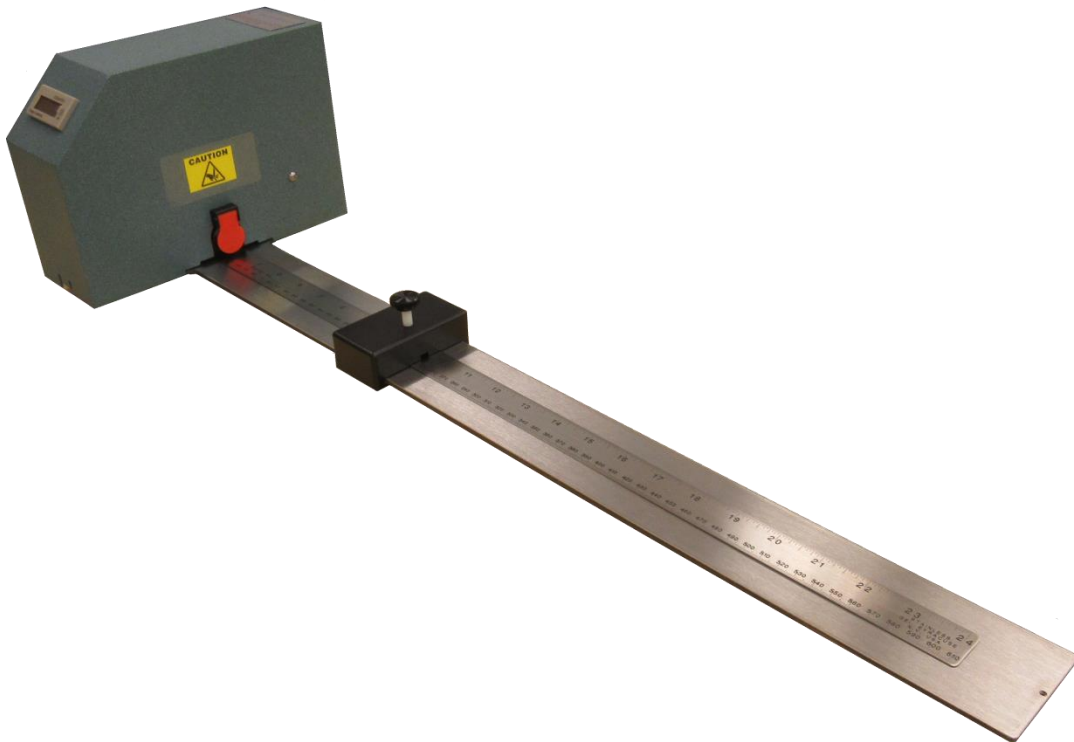

VERSION 2.1
LAST EDITED 11.18.2020
cleanroomdevices.com

Table of Contents

- Table of Contents.....2

- 1.0 General Product & Safety Information.....3
 - 1.1 Product Information
 - 1.2 Safety Information

- 2.0 Installation.....3
 - 2.1 Air Supply
 - 2.2 AC Power
 - 2.3 Foot Pedal (Accessory)

- 3.0 Operation.....5
 - 3.1 Bushing Removal
 - 3.2 Bushing Installation & Cut Angle Adjustment
 - 3.3 Cutting

- 4.0 Troubleshooting.....9

- 5.0 Maintenance.....10
 - 5.1 Blade Replacement (Razor blade)
 - 5.2 Periodic Cleaning (Annually)

- 6.0 Product Specifications and Electrical Diagram.....12

- 7.0 Durometer Scale.....12

- 8.0 Parts List.....13

- 9.0 Warranty.....14
 - 9.1 Warranty
 - 9.2 Warranty Period

1.0 General Product & Safety Information

1.1 Product Information

- The CRD170 Tubing Cutter is designed to cut flexible tubing (including heat shrink) up to a Shore A 100 durometer, including any non-metallic braided materials. The CRD170 also features an adjustable blade that can be set to cut 15°,30°,45°,60°,75° and 90° angles.
- Easily interchangeable bushings are available. The standard bushings include (12) sizes for the following outside tubing diameters: (1/16", 3/32", 1/8", 5/32", 3/16", 7/32", 1/4", 9/32", 5/16", 3/8", 7/16", 1/2"). Custom sizes are also available.
- The minimum/maximum cut lengths range from 1-1/2" to 24" long. All lengths within that range can be achieved within plus/minus .030" tolerance utilizing the slide block and scale. Minimum cut lengths of 1-1/2" can be achieved by visually locating the tube at the end of the bushing and depressing the foot pedal.

1.2 Safety Information

- This product uses an air cylinder to pneumatically actuate a cutting blade internal to the unit.
- **Do not attempt to replace the cutting blade without first disconnecting the air and power supply.**

2.0 Installation

2.1 Air Supply

- Standard facility compressed air within the range of 100-120 psi is recommended. Lower than 100 psi may affect the "cut" quality. Higher than 120 psi may reduce the life expectancy of internal parts. The air supply should be free of moisture and contaminants.
- Connect a 1/4" air supply hose to the 1/4" "**GREEN**" bulkhead connector located on the rear of the cover. *Figure 2.1.1*

Input compressed air



Figure 2.1.1

2.2 AC Power

- This product uses standard 60Hz alternating current power provided by your local utility. Ensure that you use the correct power supply (120VAC/24VDC) for the type of power in your region.
- The power supply jack is located on the rear of the cover. *Figure 2.2.1*

Power supply jack



Figure 2.2.1

2.3 *Foot pedal*

- A foot pedal is required for the operation of the CRD170.
- Insert the DIN Plug from the foot pedal into the receiving jack located on the rear of the cover. *Figure 2.3.1*

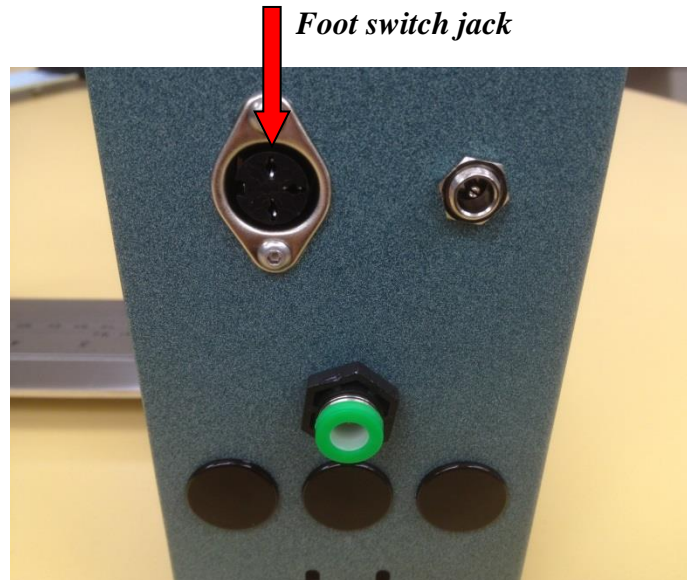

Figure 2.3.1

3.0 **Operation**

3.1 *Bushing Removal*

- Install both front and rear bushings appropriate to the outside tube diameter you intend to cut. Use the nearest equivalent if the exact size bushing set is not available.
- *NOTE: CUSTOM BUSHINGS SIZES CAN BE MADE TO ORDER BY CLEAN ROOM DEVICES, INC.*
- To swap out or install new bushings, follow the steps below:
- Disconnect the air and power supply from the rear of the cover.

- Flip the cutter upside down, loosen the outlet bushing set screw and remove bushing from cutter. *Figure 3.1.2*

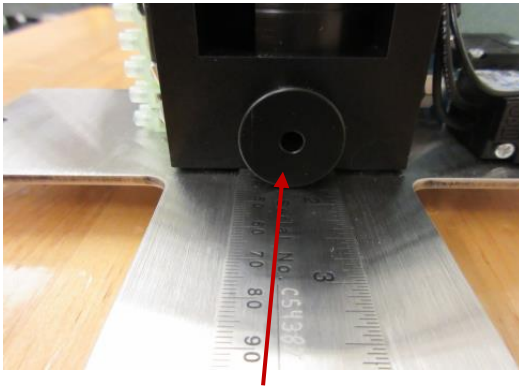

Figure 3.1.1 Outlet bushing

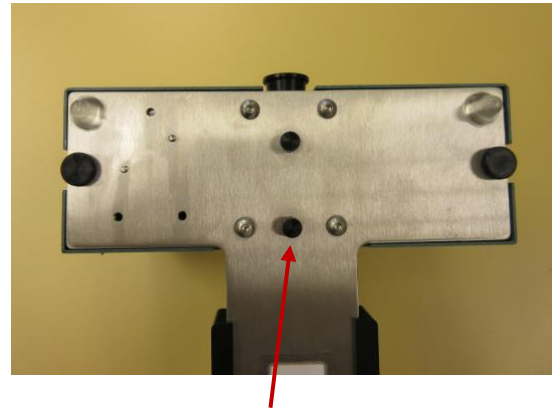

Figure 3.1.2 Bushing (outlet) set screw

- Loosen the inlet bushing set screw and remove bushing from cutter. *Figure 3.1.4*

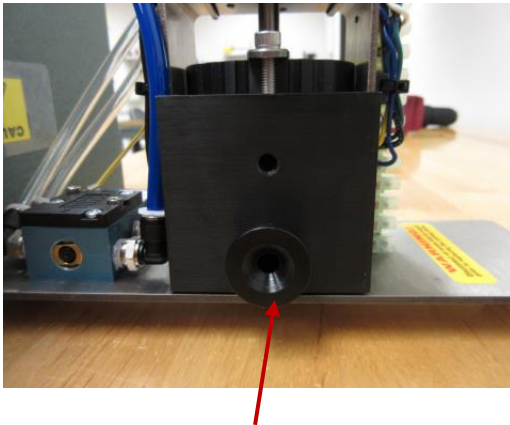

Figure 3.1.3 Inlet bushing
(Note: Inlet bushing can be identified by the countersink shown above. Inlet and outlet bushings are NOT interchangeable)

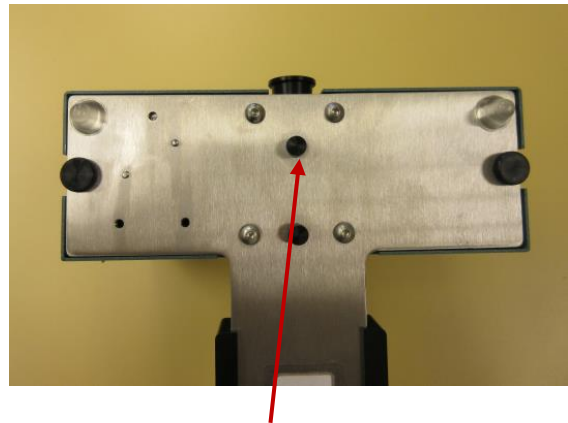

Figure 3.1.4 Bushing (inlet) set screw

3.2 Bushing Installation & Cut Angle Adjustment

- When changing bushings, cut angle may need to be adjusted to match angle of bushing set being installed. *Note: remove bushing prior to adjusting cut angle.*
- Cut angle can be adjusted using the following steps:
- Loosen screw at the rear of the knife block above the bushing hole. *Figure 3.2.1*
- Remove screw in the angle selection wheel. *Figure 3.2.2*

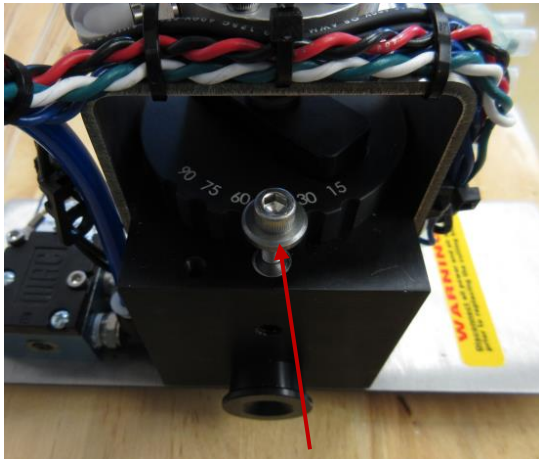

Figure 3.2.1 Loosen screw

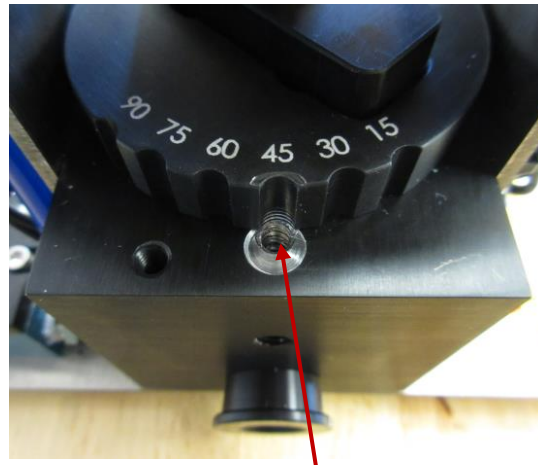

Figure 3.2.2 Remove screw and washer

- Turn angle selection wheel to desired angle to match bushing set being used and re-insert screw into the groove matching desired angle. Tighten screw.
- When installing bushings push cutting blade holder all the way down by hand. *Figure 3.2.3. (make sure air line and power are disconnected!)*

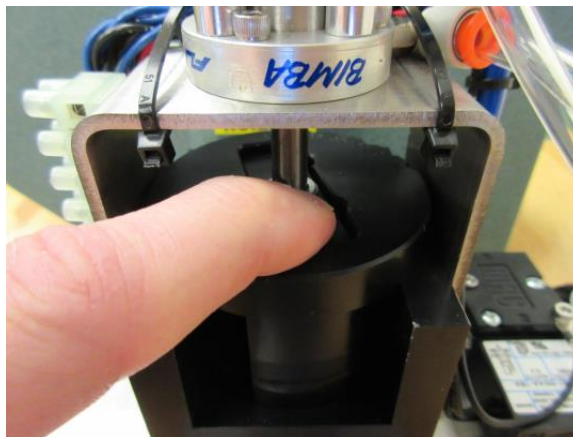

Figure 3.2.3 Push knife holder down with forefinger



Figure 3.2.4 Bushing keyways



Figure 3.2.5 Keyway pins in knife block

- Bushings are keyed so as to match the angles on the bushings. *Figure3.2.4*
- Align keyways to pins in knife block when installing bushings. *Figure3.2.5*
- Insert bushings into knife block and squeeze bushing together to sandwich blade between the bushings. *Figure 3.2.6*
- While holding bushings against blade, tighten inlet and outlet set screws. *Figure 3.1.2&3.1.4*

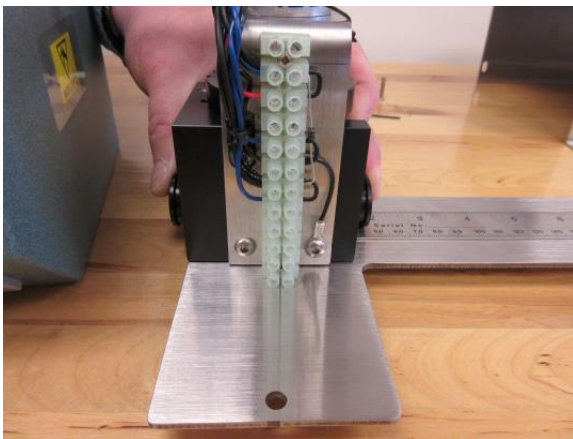

Figure 3.2.6

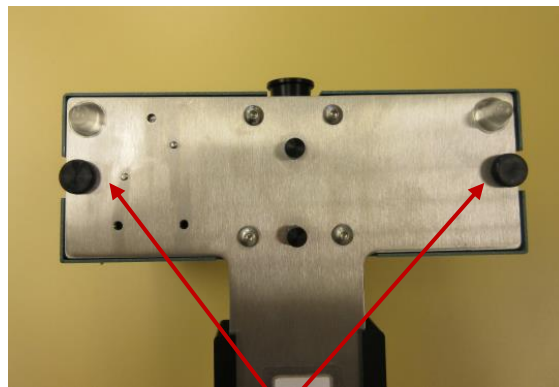

Figure 3.2.7

- Attach cover using thumb screws. *Figure 3.2.7*

3.3 Cutting

- Position the slide block to the desired cut length using the scale. Secure the slide block in position by tightening the thumb-screw clockwise; take care not to over tighten.
- Insert the tubing end into the bushing towards the direction of the slide block. Once the tubing has cleared the cover continue to pull the tubing through to where it makes contact with the slide block. Then activate the foot pedal to cut the tubing. Once cut, remove the tubing front the unit and repeat as needed.

4.0 Troubleshooting

Operating Error	Action
Unit does not have power.	<ol style="list-style-type: none">1. Check the electrical outlet or receptacle connection.2. Check the power supply jack on the cover to see if it is properly installed.
Cutting blade does not actuate.	<ol style="list-style-type: none">1. Check the facility air supply(must have a minimum of 80 psi)2. Check electrical connection.
Cutting blade makes bad cuts or leaves burrs.	<ol style="list-style-type: none">1. Ensure the tubing being cut does not exceed the recommended durometer.2. Ensure the proper bushing sizes on both sides have been installed correctly.3. Verify facility air supply psi4. Check the cutting blade for wear or damage and possible replacement.5. Slide block is not tight.
Counter is not functioning properly.	<ol style="list-style-type: none">1. Verify the counter has been reset between batch cuts or production runs.2. Check plug on counter is secure
Slide block does not move in either direction.	<ol style="list-style-type: none">1. Fully loosen the thumb screw to slide.2. Visually inspect the slide path for dirt or debris.

5.0 Maintenance

5.1 Blade Replacement (Razor blade)

- Replacement blades can be purchased from *Clean Room Devices, Inc.*
- Ensure air and power supply has been disconnected from the unit prior to removing the cover. Remove the two (2) button head cap screws securing the cover to the base plate using a 1/8 hex key. Lift cover out of the way.
- Remove bushings and rotate angle selection wheel to 90°
- You now have access to the cutting blade via the replacement window in the knife block housing. Take this opportunity to blow out any debris found within the cutter housing.
- Place a magnetic tip screwdriver (*provided*) on the cutter blade, then remove two (2) mounting screws using a 3mm hex key wrench. (*T-handle preferred*) *Figure 5.2.1*

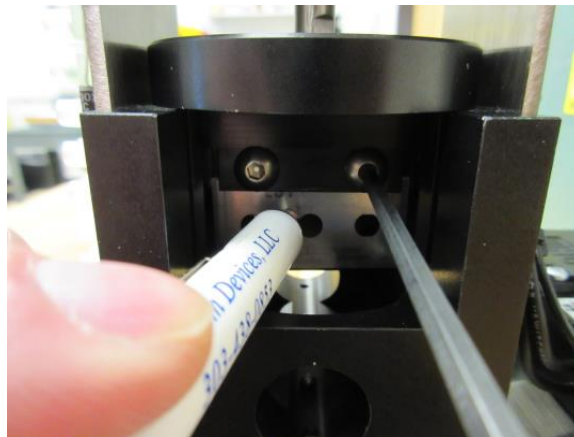

Figure 5.2.1

WARNING

Although the blade may require replacement it remains extremely sharp, handle with care. To avoid injury, proper disposal is highly recommended.

- Note that the back of the blade clamp has a lip. This must be facing toward blade when re-installing to properly hold the blade. **Figure 5.2.2**

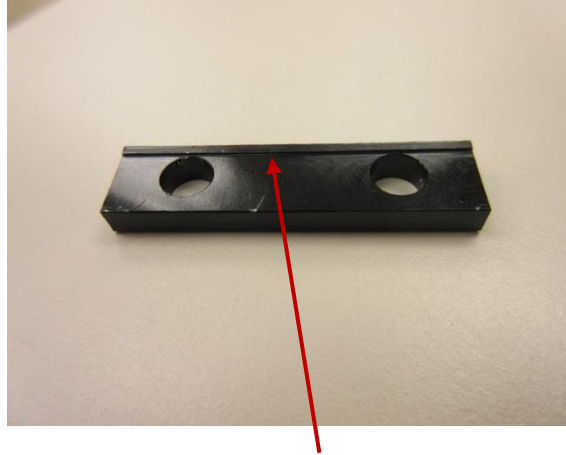

Figure 5.2.2 *Showing lip on back (blade) side of clamp*

- Install the new razor blade using a magnetic screwdriver and reusing the same screws.
- Rotate blade back to desired angle and reinstall bushings (section 3.2).
- Re-install the cover and tighten mounting screws and reconnect air supply. Make a few test cuts to verify quality and that the unit is working properly prior to production runs.
- The knife blade screws should be checked periodically for tightness. ***Do not over tighten.***

5.2 *Periodic Cleaning (annually or as needed)*

- Wipe down outer surfaces with alcohol, septihol or mild detergents, specifically those surfaces/grooves that come in contact with the slide block.
- Inspect the blade housing cavity (by removing the cover), blow-out any/all debris.

6.0 Product Specifications and Electrical Diagram

Unit Weight	8.5 LBS / 3.85 KG
Overall Dimensions	28" lg. x 9 3/16" w x 6 3/8" ht.
Minimum/Maximum PSI	100 PSI / 120 PSI
Electrical Power	120VAC/24VDC Power Supply

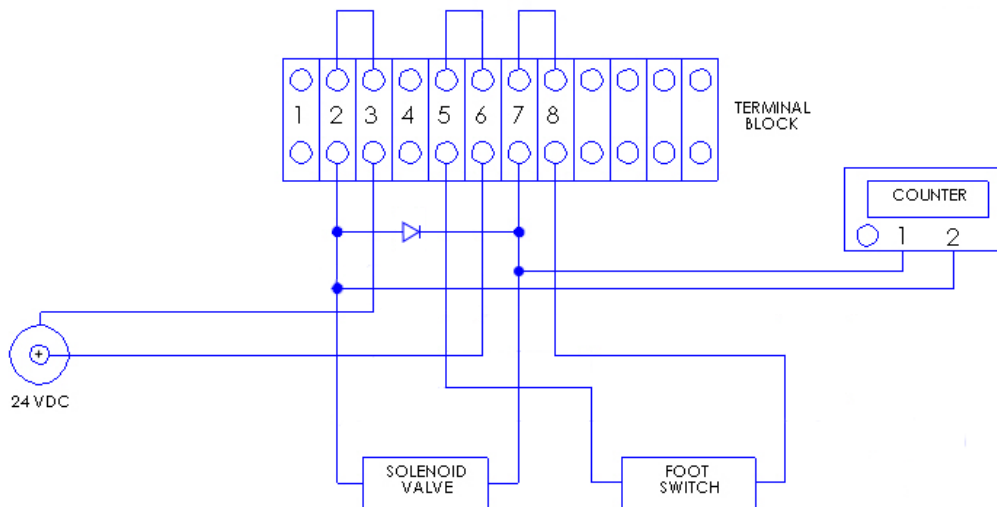

WIRING DIAGRAM

7.0 Durometer Scale

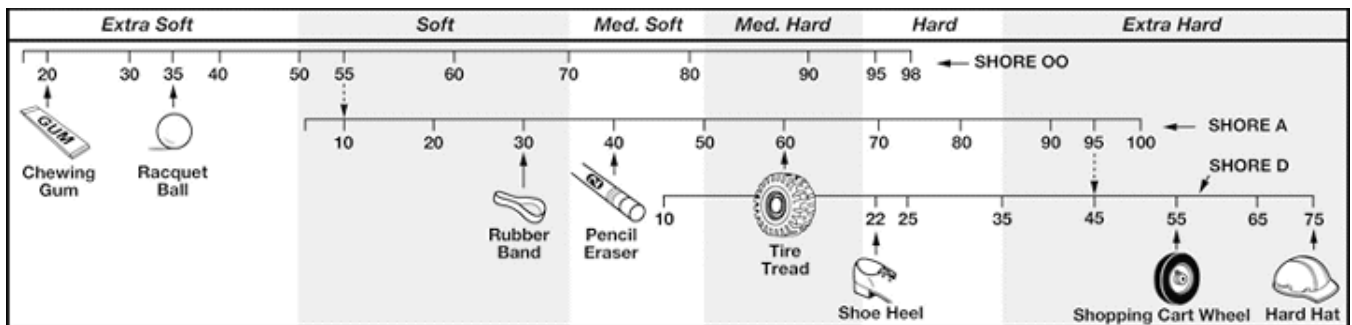

8.0 Parts List

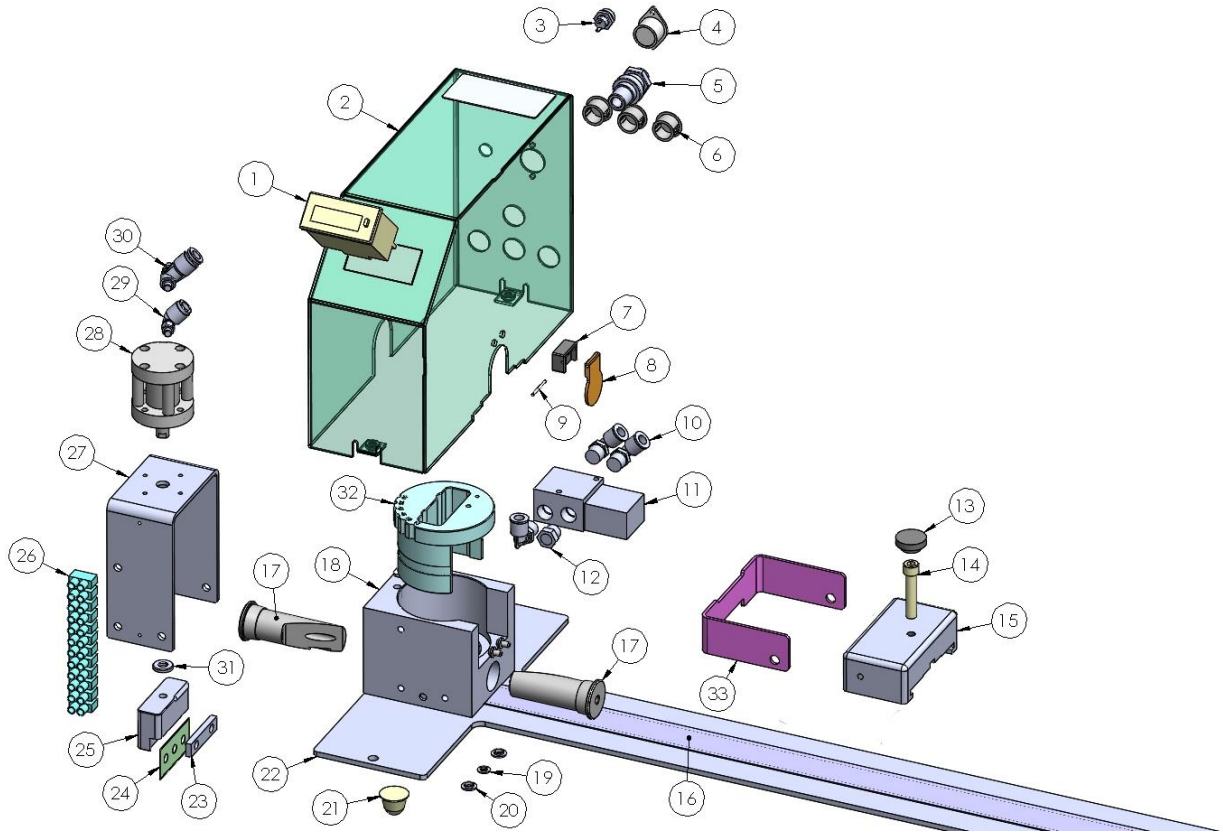

Item	Part Number	Description	Item	Part Number	Description
1	P00001	Counter	18	CD170-001	Knife Block
2	CD120-009	Electronics Cover	19	P00367	Small Shoulder Washer
3	P00439	Power Jack	20	P00368	Large Shoulder Washer
4	P00205	3-Pin Foot Pedal Jack	21	P00348	Rubber Foot
5	P00495	¼" Bulkhead	22	CD120-006	Stainless Steel Base
6	P00372	Plastic Plug	23	CD170-003	Blade Clamp
7	CD100-044	Flapper Mount	24	RB100	Razor Blade
8	CD100-045	Flapper	25	CD170-002	Knife Holder
9	P00435	SS Slotted Spring Pin	26	P00217	Terminal Strip
10	P00063	90° Elbow	27	CD170-004	Cylinder Bracket
11	P0008	MAC Valve w/Solenoid	28	P00012	Pneumatic Cylinder
12	P00022	Muffler	29	TS00128	90° Elbow
13	P00347	Plastic Screw Head	30	P00402	Flow Valve
14	P00346	¼-20 Nylon SHCS	31	P00053	Extra Thick #10 Washer
15	CD130-008	Slide Block, Short Cut	32	CD170-005	Rotating Insert
16	P00003	24" SS Ruler	33	CD120-021	Rotating Stop Arm
17	AB###	Bushing Set (Razor)			

9.0 Warranty

9.1 Warranty

The manufacturer warrants the product manufactured by it, when properly installed, operated, applied and maintained in accordance with the procedures and recommendations outlined in the manufacturer's operation manual, to be free from defects in material or workmanship for a period as specified below, provided such defect is discovered and brought to the manufacturer's attention within the stated warranty period.

The manufacturer will repair or replace any product or part determined to be defective by the manufacturer within the warranty period, provided such defect occurred in the normal service and not as a result of misuse, abuse, neglect or accident. Normal maintenance items requiring routine replacement are not warranted. The warranty covers parts and labor for the warranty period unless otherwise specified. Repair or replacement shall be made at the factory or the installation site, at the sole discretion of the manufacturer. Any service performed on the product by anyone other than the manufacturer must first be authorized by the manufacturer.

Unauthorized service voids the warranty and any resulting charge or subsequent claim will not be paid. Products repaired or replaced under warranty shall be warranted for the unexpired portion of the warranty applying to the original product.

The foregoing is the exclusive remedy of any buyer of the manufacturer's product. The maximum damages liability for the manufacturer is the original purchase price of the product or part.

THE FOREGOING WARRANTY IS EXCLUSIVE AND IN LIEU OF ALL OTHER WARRANTIES, WHETHER WRITTEN, ORAL, OR STATUTORY, AND IS EXPRESSLY IN LIEU OF THE IMPLIED WARRANTY OF MERCHANTABILITY AND THE IMPLIED WARRANTY OF FITNESS FOR A PARTICULAR PURPOSE. THE MANUFACTURER SHALL NOT BE LIABLE FOR LOSS OR DAMAGE BY REASON OF STRICT LIABILITY IN TORT OR ITS NEGLIGENCE IN WHATEVER MANNER INCLUDING DESIGN, MANUFACTURE OR INSPECTION OR THE EQUIPMENT OR ITS FAILURE TO DISCOVER, REPORT, REPAIR, OR MODIFY LATENT DEFECTS INHERENT THEREIN.

THE MANUFACTURER, HIS REPRESENTATIVE OR DISTRIBUTOR SHALL NOT BE LIABLE FOR LOSS OF USE OF THE PRODUCT OR OTHER INCIDENTAL OR CONSEQUENTIAL COSTS, EXPENSES, OR DAMAGES INCURRED BY THE BUYER, WHETHER ARISING FROM BREACH OF WARRANTY, NEGLIGENCE OR STRICT LIABILITY IN TORT.

The manufacturer does not warrant any product, part, material, component, or accessory manufactured by others and sold or supplied in connection with the sale of manufacturer's products.

9.2 Warranty Period

Parts and labor are for ninety (90) days from the date of shipment from the factory. Freight to the factory on units that the manufacturer requests to be returned shall be paid by the purchaser, all return freight to be paid by the manufacturer; means of transportation to be specified by the manufacturer.

For additional information contact: www.cleanroomdevices.com

Clean Room Devices, Inc.
10855 Dover Street, Suite 100
Westminster, CO 80021
303-438-0853