

 **CLEAN ROOM DEVICES, INC.**

# **CRD190 V-NOTCH TUBING CUTTER**

## **OPERATIONS MANUAL**

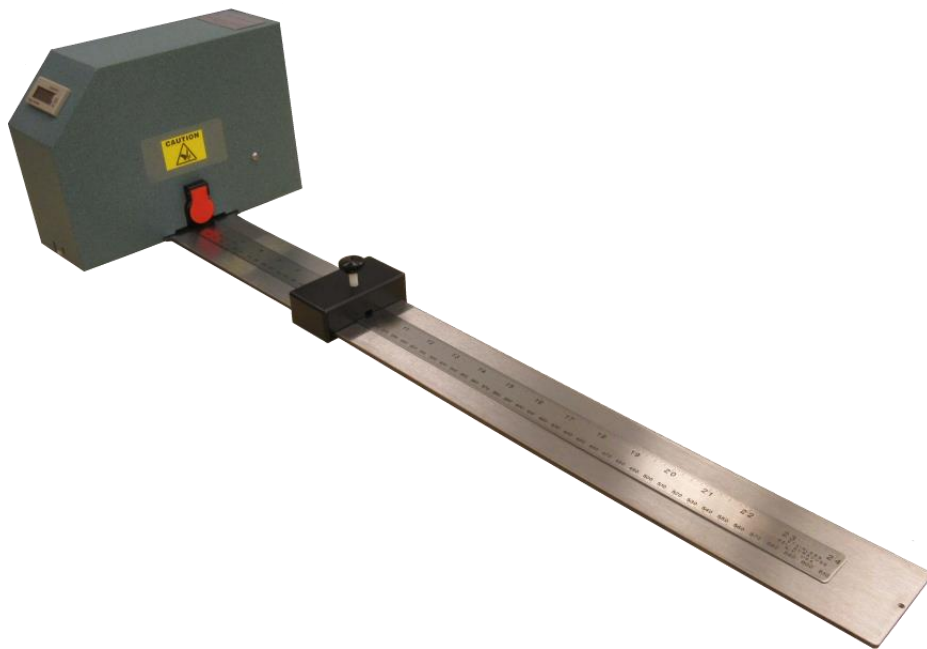

VERSION 2.1  
LAST EDITED 11.18.2020  
*cleanroomdevices.com*

# Table of Contents

- Table of Contents.....2
- 1.0 General Product & Safety Information.....3
  - 1.1 Product Information
  - 1.2 Safety Information
- 2.0 Installation.....3
  - 2.1 Air Supply
  - 2.2 AC Power
  - 2.3 Foot Pedal (Accessory)
- 3.0 Operation.....5
  - 3.1 Bushing installation
  - 3.2 Cutting
- 4.0 Troubleshooting.....7
- 5.0 Maintenance.....7
  - 5.1 Blade Replacement
  - 5.2 Periodic Cleaning (Annually)
- 6.0 Product Specifications and Electrical Diagram.....10
- 7.0 Durometer Scale.....10
- 8.0 Parts List.....11
- 9.0 Warranty.....12
  - 9.1 Warranty
  - 9.2 Warranty Period

## 1.0 General Product & Safety Information

### 1.1 Product Information

- The CRD190 Tubing Cutter is designed to cut flexible tubing (including heat shrink) up to a Shore A 100 durometer, including any non-metallic braided materials.
- Easily interchangeable bushings are available. The standard bushings include (7) sizes for the following outside tubing diameters: (1/16", 3/32", 1/8", 5/32", 3/16", 7/32", 1/4") Custom sizes are also available.
- The minimum/maximum cut lengths range from 1/2" to 24" long. All lengths within that range can be achieved within plus/minus .030" tolerance utilizing the slide block and scale. Minimum cut lengths of 1-25/32" can be achieved by visually locating the tube at the end of the bushing and depressing the foot pedal.
- Cut lengths down to 1/2" (+/- .002) can be obtained with adjustable stop pin (optional).

### 1.2 Safety Information

- This product uses an air cylinder to pneumatically actuate a cutting blade internal to the unit.
- **Do not attempt to replace the cutting blades without first disconnecting the air and power supply.**

## 2.0 Installation

### 2.1 Air Supply

- Standard facility compressed air within the range of 100-120 psi is recommended. Lower than 100 psi may affect the "cut" quality. Higher than 120 psi may reduce the life expectancy of internal parts. The air supply should be free of moisture and contaminants.
- Connect a 1/4" air supply hose to the 1/4" "**GREEN**" bulkhead connector located on the rear of the cover. *Figure 2.1.1*

*Input compressed air*

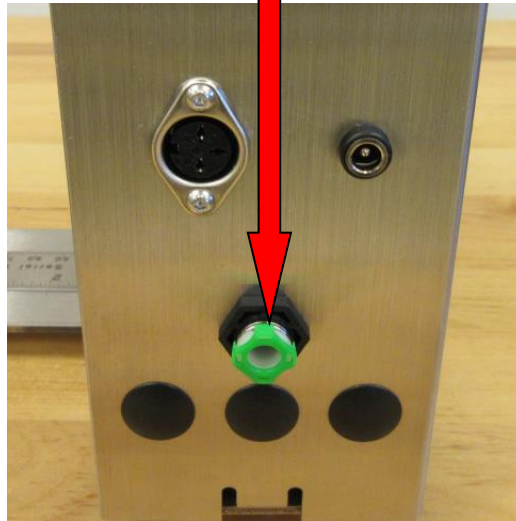
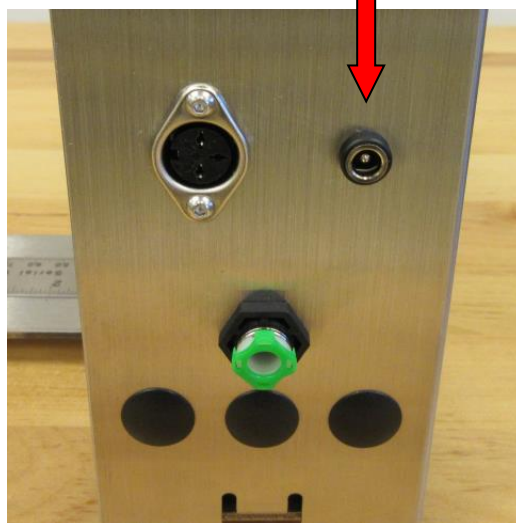

*Figure 2.1.1*

## 2.2 AC Power

- This product uses standard 60Hz alternating current power provided by your local utility. Ensure that you use the correct power supply (120VAC/24VDC) for the type of power in your region.
- The power supply jack is located on the rear of the cover. *Figure 2.2.1*

*Power supply jack*



*Figure 2.2.1*

### 2.3 *Foot pedal*

- A foot pedal is required for the operation of the CRD190.
- Insert the DIN Plug from the foot pedal into the receiving jack located on the rear of the cover. *Figure 2.3.1*



*Figure 2.3.1*

## 3.0 **Operation**

### 3.1 *Bushing installation*

- Install both front and rear bushings appropriate to the outside tube diameter you intend to cut. Use the nearest equivalent if the exact size bushing set is not available.
- *NOTE: CUSTOM BUSHINGS SIZES CAN BE MADE TO ORDER BY CLEAN ROOM DEVICES, INC.*
- To swap out or install new bushings, follow the steps below:
- Disconnect the air and power supply from the rear of the cover.

- Flip the cutter upside down.
- Loosen the bushing thumb screws and remove bushings from cutter. *Figure 3.1.1*
- Replace with new/different size bushings into the cutter and tighten the thumb screws.

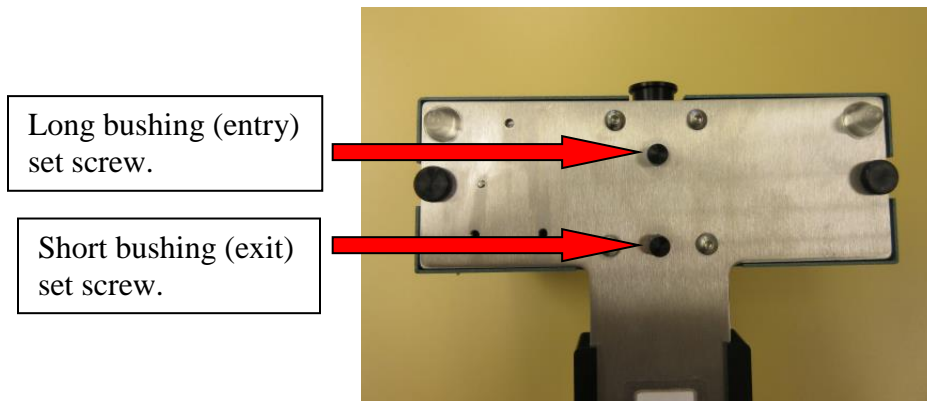

*Figure 3.1.1 Bushing thumb screws*

### 3.2 *Cutting*

- Position the slide block to the desired cut length using the scale. Secure the slide block in position by tightening the thumb-screw clockwise; take care not to over tighten.
- Insert the tubing end into the bushing towards the direction of the slide block. Once the tubing has cleared the cover continue to pull the tubing through to where it makes contact with the slide block. Then activate the foot switch to cut the tubing. Once cut, remove the tubing from the unit and repeat as needed.

## 4.0 Troubleshooting

Operating Error	Action
Unit does not have power.	<ol style="list-style-type: none"> <li>1. Check the electrical outlet or receptacle connection.</li> <li>2. Check the power supply jack on the cover to see if it is properly installed.</li> </ol>
Cutting blade does not actuate.	<ol style="list-style-type: none"> <li>1. Check the facility air supply(must have a minimum of 80 psi)</li> <li>2. Check electrical connection.</li> </ol>
Cutting blade makes bad cuts or leaves burrs.	<ol style="list-style-type: none"> <li>1. Ensure the tubing being cut does not exceed the recommended durometer.</li> <li>2. Ensure the proper bushing sizes on both sides have been installed correctly.</li> <li>3. Verify facility air supply psi</li> <li>4. Check the cutting blade for wear or damage and possible replacement.</li> <li>5. Slide block is not tight.</li> </ol>
Counter is not functioning properly.	<ol style="list-style-type: none"> <li>1. Verify the counter has been reset between batch cuts or production runs.</li> <li>2. Check plug on counter is secure</li> </ol>
Slide block does not move in either direction.	<ol style="list-style-type: none"> <li>1. Fully loosen the thumb screw to slide.</li> <li>2. Visually inspect the slide path for dirt or debris.</li> </ol>

## 5.0 Maintenance

### 5.1 Blade Replacement

- Replacement blades can be purchased from *Clean Room Devices, Inc.*
- Ensure air and power supply has been disconnected from the unit prior to removing the cover. Remove the two thumb screws securing the cover to the base plate. Lift cover out of the way. *See Figure 5.1.1*
- You now have access to the insert which can be carefully removed by removing the 2 screws holding it in with a 1/8" hex wrench. Take this opportunity to blow out any debris found within the cutter housing. *Figure 5.1.2*

- Once the insert is removed you will have access to the blade clamp screws holding the blades in place using a 3/32" hex key wrench. (*T-handle preferred*), *Figure 5.1.3*

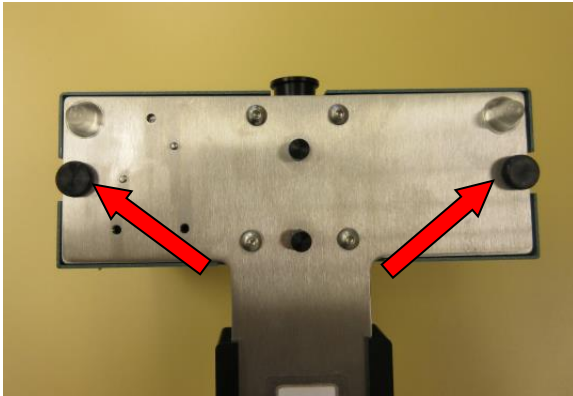

*Figure 5.1.1 Cover screws*

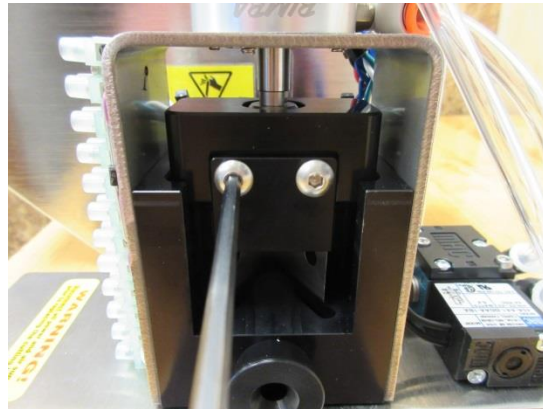

*Figure 5.1.2*

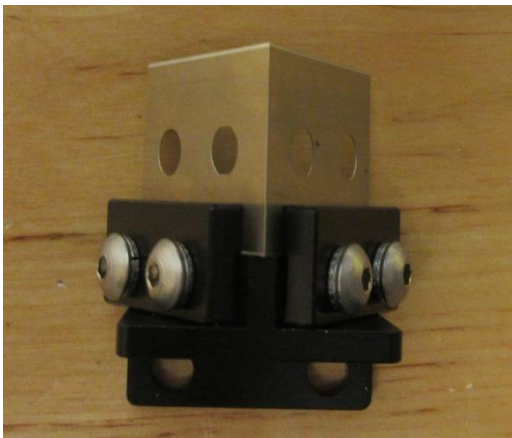

*Figure 5.1.3*

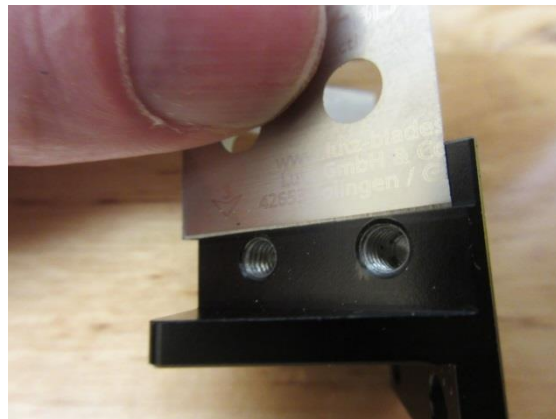

*Figure 5.1.4*

- Install the new knife blades using a magnetic screwdriver and reusing the same screws.
- When installing the new blades make sure to properly position them on the small ledge on the insert and mate the factory edges (with the up and down arrows) together *Figure 5.1.4 & 5.1.5*



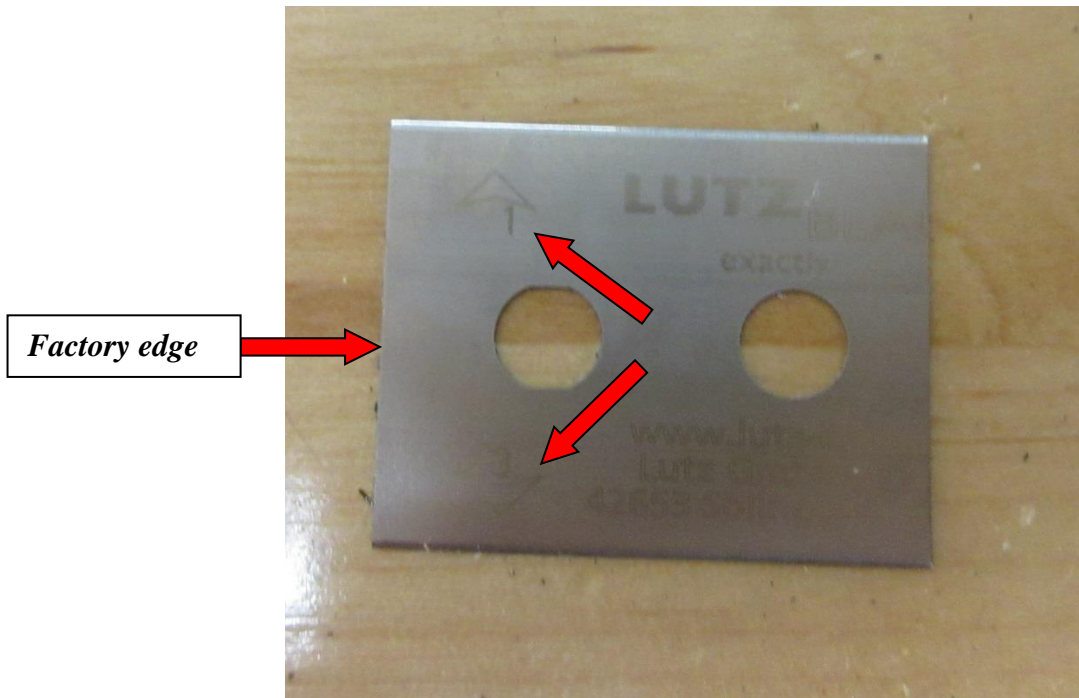

*Figure 5.1.5 showing numbered arrows which indicate the factory or uncut edge*

**WARNING**

*Although the blade may require replacement it remains extremely sharp, handle with care. To avoid injury, proper disposal is highly recommended.*

- Re-install the cover and tighten mounting screws and reconnect air supply. Make a few test cuts to verify quality and that the unit is working properly prior to production runs.
- The knife blade screws should be checked periodically for tightness. ***Do not over tighten.***

## 5.2 *Periodic Cleaning (annually or as needed)*

- Wipe down outer surfaces with alcohol, septihol or mild detergents, specifically those surfaces/grooves that come in contact with the slide block.
- Inspect the blade housing cavity (by removing the cover), blow-out any/all debris.

## 6.0 Product Specifications and Electrical Diagram

Unit Weight	8.5 LBS / 3.85 KG
Overall Dimensions	28" lg. x 9 3/16" w x 6 3/8" ht.
Minimum/Maximum PSI	100 PSI / 120 PSI
Electrical Power	120VAC/24VDC Power Supply

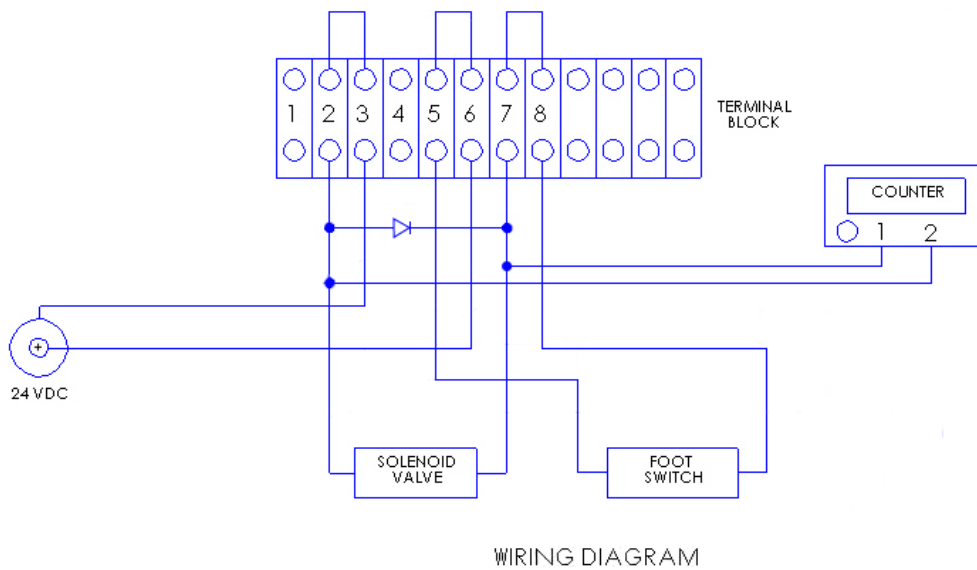

## 7.0 Durometer Scale

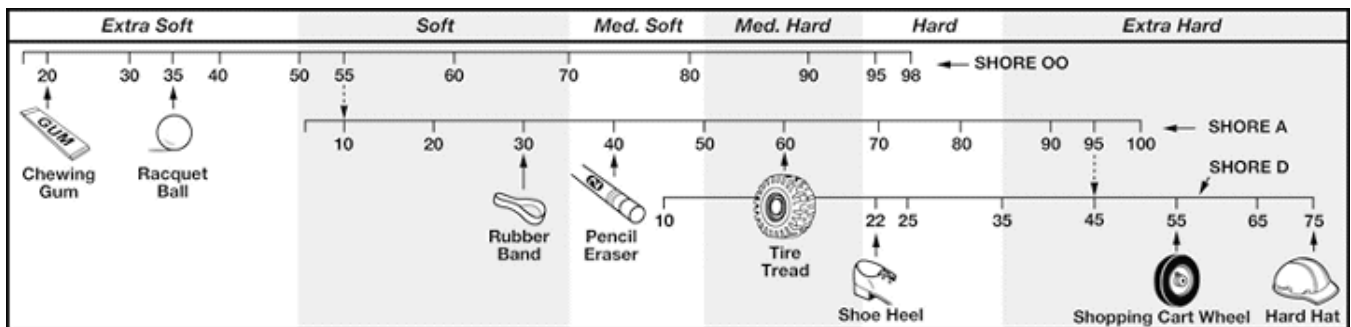

## 8.0 Parts List

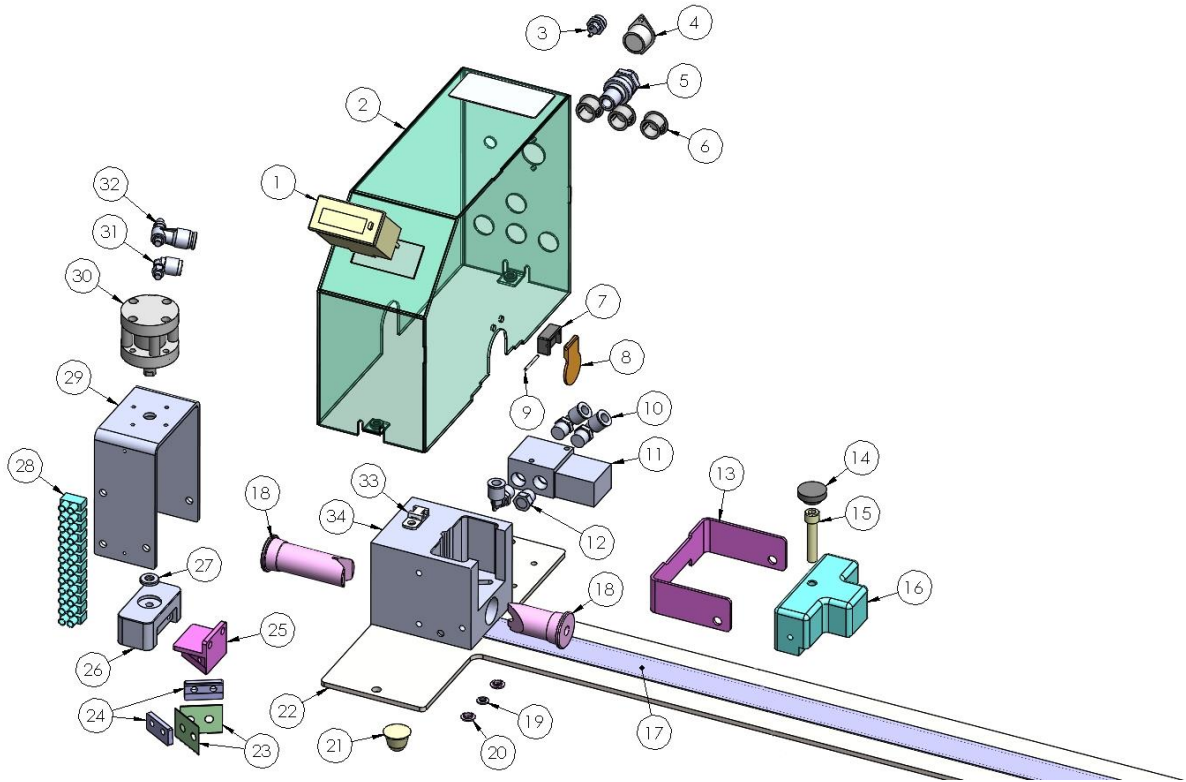

Item	Part Number	Description	Item	Part Number	Description
1	P00001	Counter	18	190-006,007	Bushing
2	CD120-009ss	Electronics Cover	19	P00367	Small Shoulder Washer
3	P00439	Power Jack	20	P00368	Large Shoulder Washer
4	P00205	3-Pin Foot Pedal Jack	21	P00348	Rubber Foot
5	P00495	1/4" Bulkhead	22	CD120-006	Stainless Steel Base
6	P00372	Plastic Plug	23	190-005	Razor Blade
7	CD100-044	Flapper Mount	24	190-008	Blade Clamps
8	CD100-045	Flapper	25	190-004	Insert
9	P00435	SS Slotted Spring Pin	26	190-003	Knife Holder
10	P00063	90° Elbow	27	P00053	Extra Thick #10 Washer
11	P0008	MAC Valve w/Solenoid	28	P00217	Terminal Strip
12	P00022	Muffler	29	CD120-002	Cylinder Bracket
13	CD120-021	Rotating Stop Arm(option)	30	P00012	Pneumatic Cylinder
14	P00347	Plastic Screw Head	31	TS00128	90° Elbow
15	P00346	1/4-20 Nylon SHCS	32	P00402	Flow Valve
16	CD130-003	Slide Block	33	P00109	Cable Tie Mount
17	P00003	24" SS Ruler	34	190-001	Knife Block

## 9.0 Warranty

### 9.1 Warranty

The manufacturer warrants the product manufactured by it, when properly installed, operated, applied and maintained in accordance with the procedures and recommendations outlined in the manufacturer's operation manual, to be free from defects in material or workmanship for a period as specified below, provided such defect is discovered and brought to the manufacturer's attention within the stated warranty period.

The manufacturer will repair or replace any product or part determined to be defective by the manufacturer within the warranty period, provided such defect occurred in the normal service and not as a result of misuse, abuse, neglect or accident. Normal maintenance items requiring routine replacement are not warranted. The warranty covers parts and labor for the warranty period unless otherwise specified. Repair or replacement shall be made at the factory or the installation site, at the sole discretion of the manufacturer. Any service performed on the product by anyone other than the manufacturer must first be authorized by the manufacturer.

Unauthorized service voids the warranty and any resulting charge or subsequent claim will not be paid. Products repaired or replaced under warranty shall be warranted for the unexpired portion of the warranty applying to the original product.

The foregoing is the exclusive remedy of any buyer of the manufacturer's product. The maximum damages liability for the manufacturer is the original purchase price of the product or part.

THE FOREGOING WARRANTY IS EXCLUSIVE AND IN LIEU OF ALL OTHER WARRANTIES, WHETHER WRITTEN, ORAL, OR STATUTORY, AND IS EXPRESSLY IN LIEU OF THE IMPLIED WARRANTY OF MERCHANTABILITY AND THE IMPLIED WARRANTY OF FITNESS FOR A PARTICULAR PURPOSE. THE MANUFACTURER SHALL NOT BE LIABLE FOR LOSS OR DAMAGE BY REASON OF STRICT LIABILITY IN TORT OR ITS NEGLIGENCE IN WHATEVER MANNER INCLUDING DESIGN, MANUFACTURE OR INSPECTION OR THE EQUIPMENT OR ITS FAILURE TO DISCOVER, REPORT, REPAIR, OR MODIFY LATENT DEFECTS INHERENT THEREIN.

THE MANUFACTURER, HIS REPRESENTATIVE OR DISTRIBUTOR SHALL NOT BE LIABLE FOR LOSS OF USE OF THE PRODUCT OR OTHER INCIDENTAL OR CONSEQUENTIAL COSTS, EXPENSES, OR DAMAGES INCURRED BY THE BUYER, WHETHER ARISING FROM BREACH OF WARRANTY, NEGLIGENCE OR STRICT LIABILITY IN TORT.

The manufacturer does not warrant any product, part, material, component, or accessory manufactured by others and sold or supplied in connection with the sale of manufacturer's products.

### 9.1 Warranty Period

Parts and labor are for ninety (90) days from the date of shipment from the factory. Freight to the factory on units that the manufacturer requests to be returned shall be paid by the purchaser, all return freight to be paid by the manufacturer; means of transportation to be specified by the manufacturer.

*For additional information contact: [www.cleanroomdevices.com](http://www.cleanroomdevices.com)*

Clean Room Devices, Inc.  
10855 Dover Street, Suite 100  
Westminster, CO 80021  
303-438-0853