

 **CLEAN ROOM DEVICES, INC.**

CRD600AF
Automatic Fitting Inserter
With Auto Feed

OPERATIONS MANUAL

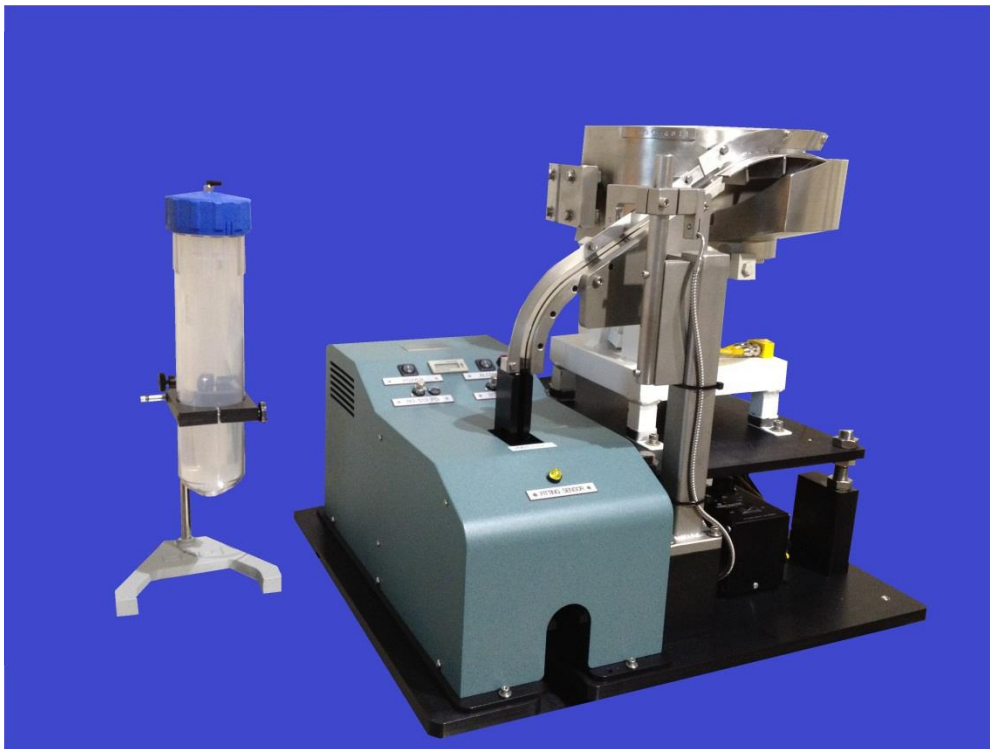

(Shown with optional alcohol dispenser)

VERSION 1.4
LAST EDITED 07.22.2020
cleanroomdevices.com

Table of Contents

Title Page.....	1
Table of Contents.....	2
1.0 General Product & Safety Information.....	3
1.1 Product Information	
1.2 Safety Information	
2.0 Installation/Setup.....	3
2.0 Mounting the Bowl Fill Sensor & Mast	
2.1 Vibratory Bowl Electrical	
2.2 Fitting Inserter Air Supply	
2.3 Fitting Inserter Electrical	
2.4 Pin Set Installation	
2.5 Jaw Set Installation	
2.6 Adjusting the Stop Gate	
2.7 Magazine Installation	
2.8 Adjusting Last Fitting Sensor	
3.0 Operation.....	17
3.1 Loading Magazine and Jaws	
3.2 Fitting Sensor Lamp	
3.3 Vibromatic Controller	
4.0 Removing Fitting Inserter From Base.....	18
4.1 Clearing Vibratory Bowl Track and Separating Fitting Inserter	
5.0 Maintenance.....	20
5.1 Daily	
5.2 Every Three Months	
6.0 Recommended Spare Parts.....	21
7.0 Product Specifications.....	21
8.0 Trouble Shooting.....	22
9.0 Durometer Scale.....	22
10.0 Electrical & Pneumatic Diagrams.....	23
11.0 Vibratory Hopper Option.....	25
12.0 Alcohol Dispenser Option.....	28
13.0 Warranty.....	33
13.1 Warranty	
13.2 Warranty Period	

1.0 General Product & Safety Information

1.1 Product Information

- The Automatic Bowl Feed Fitting Inserter is designed to hold and locate soft tubing while inserting a fitting into the tubing.
- The minimum/maximum outside tube diameter is 3/32” to 9/16”

1.2 Safety Information

- This product uses air cylinders and electronic sensors to pneumatically actuate the closing jaws. The unit is not intended for anything other than flexible tubing.

Safety Notice

The CRD600AF Automatic Fitting Inserter should only be operated by trained, qualified personnel, who have read and understand this manual.

The owner of this CRD600AF is responsible for training all personnel to properly operate this unit. Failure to follow instructions may result in serious personal injury.

Never, under any circumstances operate the “Automatic Fitting Inserter” with the cover or any guards removed or any safety device disabled.

At the time of this writing the content of this manual was up-to-date. However, due to continual improvements in unit design, it is possible some descriptions and procedures contained herein vary from the unit actually delivered to you.

2.0 Installation/Setup

- Ensure all five (5) rubber feet are completely stabilized on your work surface prior to applying air pressure and electrical power to the unit.
- After removing the 600AF from the crate and preparing to set it up, the Vibratory Bowl fill sensor will have to be installed onto the upper plate of the unit.
- After carefully unwrapping the Bowl Fill Sensor Mast, position it so that the armored cables are located to either side of the mast base, and the flat back of the upper mast faces the lower mast. *Figure A*

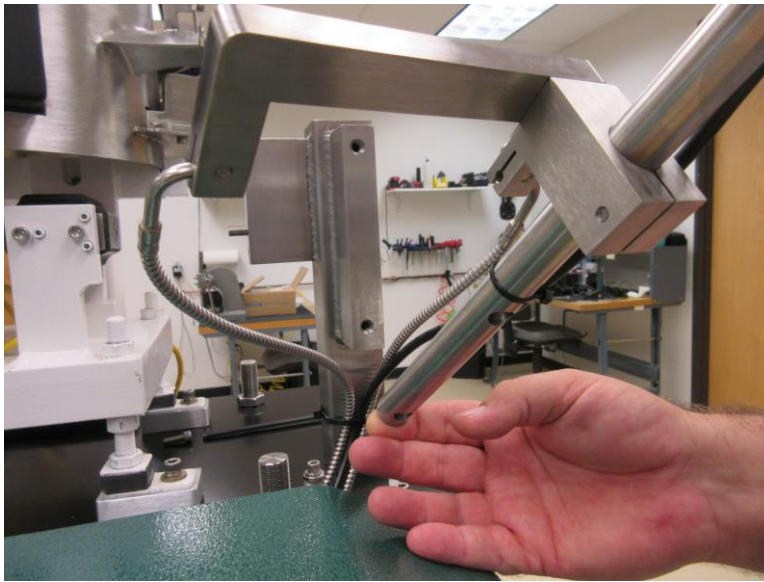

Figure A

- Once the upper portion of the mast is oriented properly, use a 3/16" hex wrench to install and fully tighten both screws. *Figures B - G*

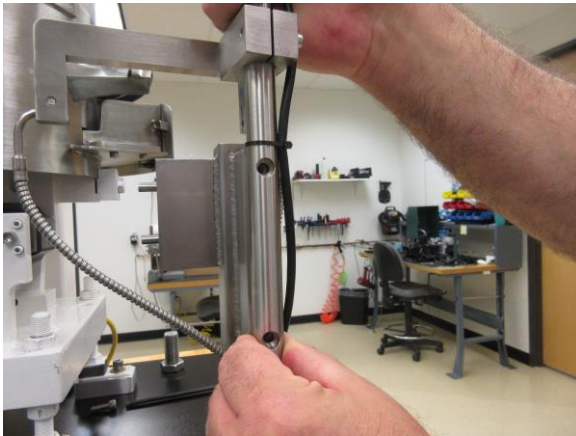

Figure B



Figure C

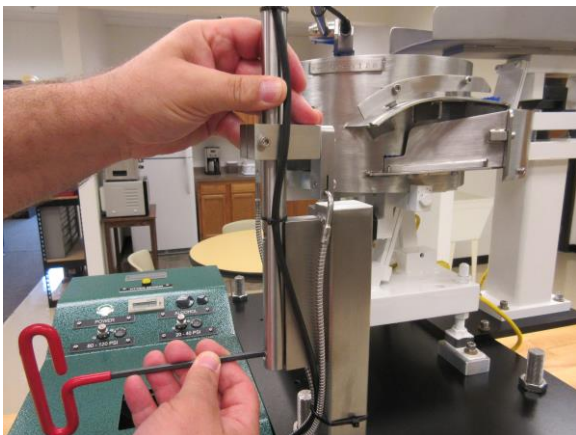

Figure D



Figure E

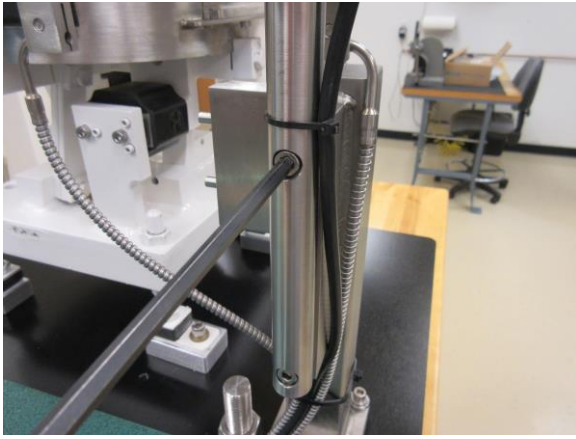

Figure F

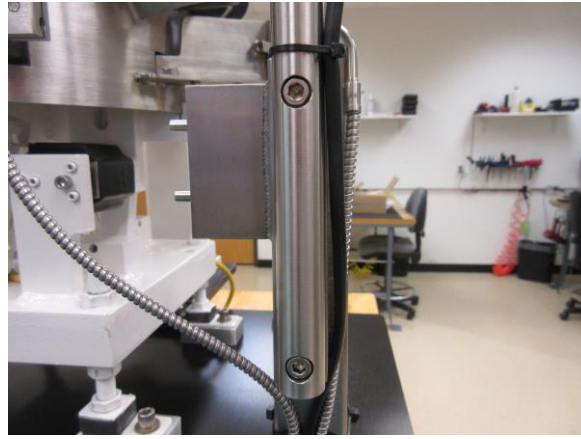

Figure G

2.1 Vibratory Bowl Electrical

- Ensure the Vibromatic controller is in the “OFF” position. Plug the Vibromatic power supply into a 110V AC outlet.

2.2 Fitting Inserter Air Supply

- Connect a 1/4” air supply hose to the fitting found on the back of the Automatic Fitting Inserter. *Figure 2.2.1* The air supply should be free of moisture and contaminants and capable of supplying **100-120** psi. It is important to have the ability to shut off the air pressure or disconnect from the main air line. A quick-connect coupling or ball valve is recommended.
- The air supply will need to be off or disconnected when manually cycling the pin set actuation air cylinder.
- Adjust low pressure regulator between 20-30 psi. *Figure 2.2.2*
- Adjust high pressure regulator between 80-100 psi. *Figure 2.2.2*
Must have a minimum of 100 psi to function properly.

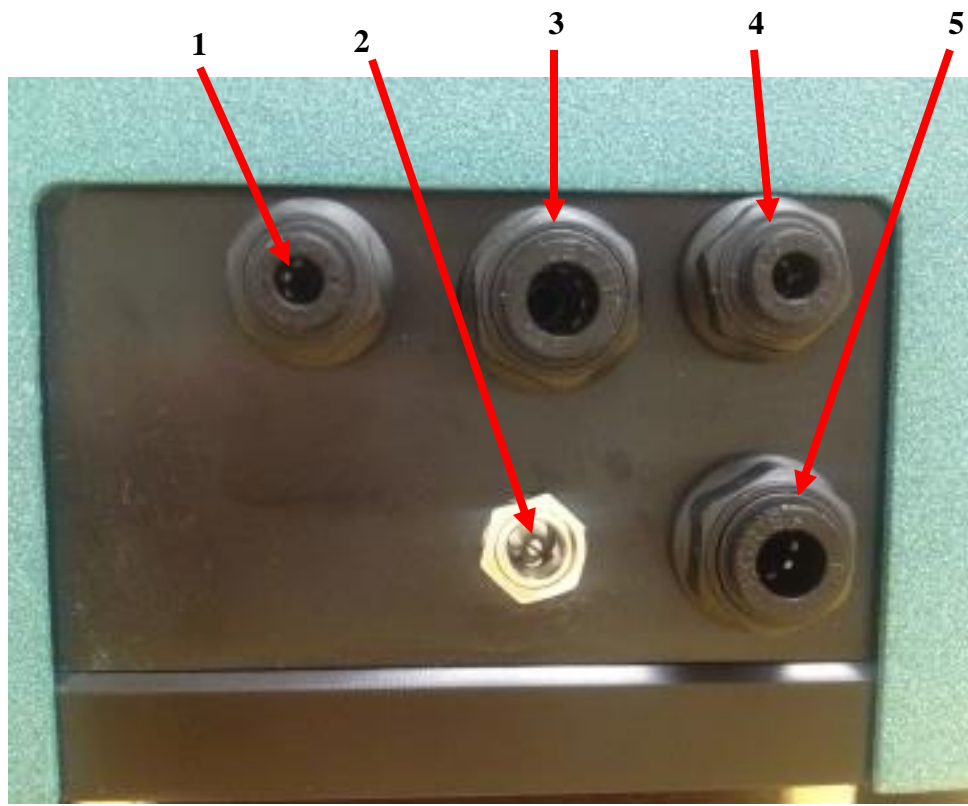

Figure 2.2.1

1. Return from Alcohol Dispenser, use 5/32" tubing
2. 24 VDC Power Supply Jack
3. Compressed Air Supply, use 1/4" tubing
4. Air Supply to Alcohol Dispenser, use 5/32" tubing
5. Alcohol drip tray drain, use 1/4" tubing

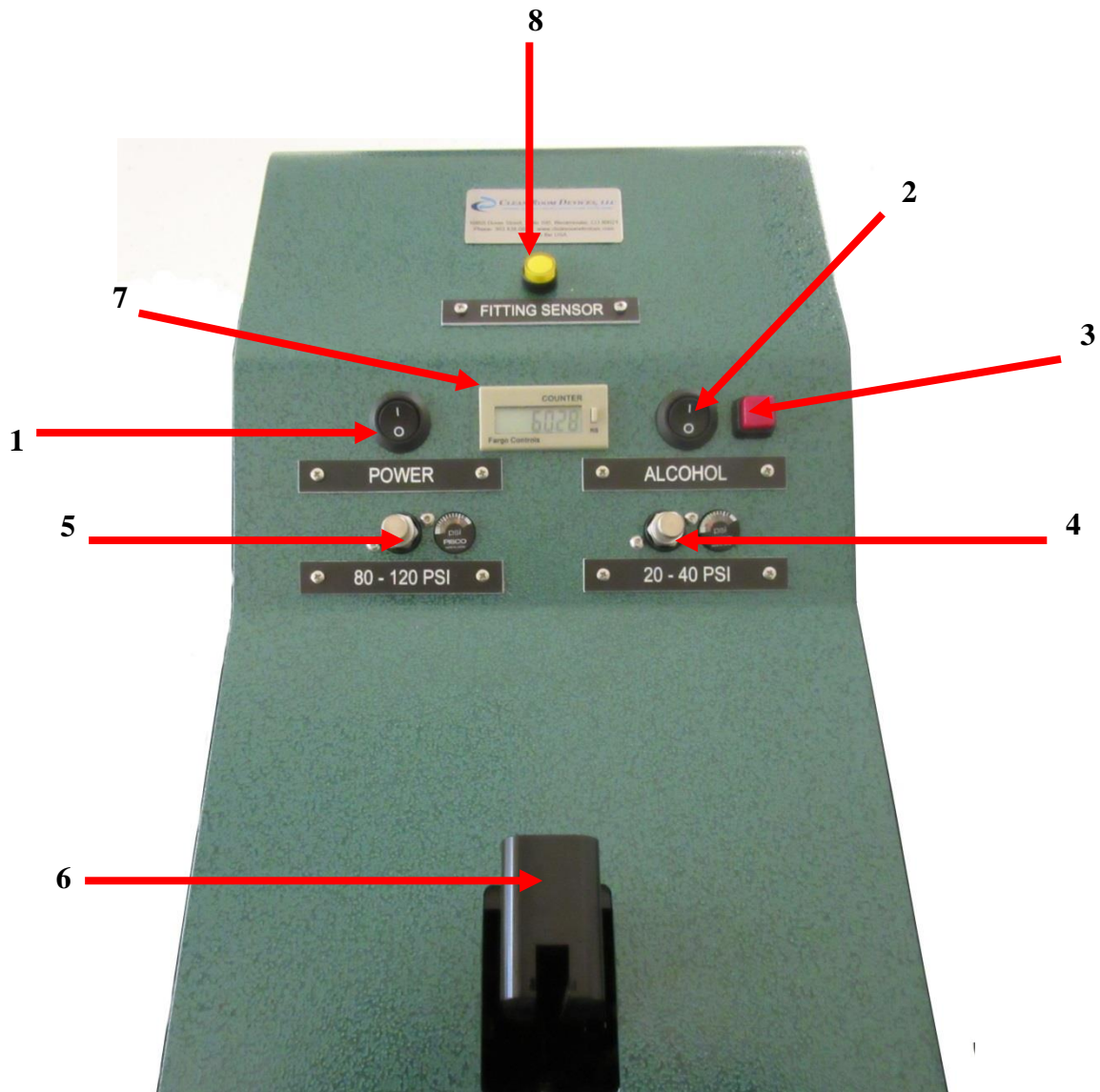

Figure 2.2.2

1. Power On/Off Switch
2. Alcohol Dispenser On/Off Switch
3. Alcohol Primer On/Off Switch
4. Low Pressure, Regulator/Gauge
5. High Pressure, Regulator/Gauge
6. Magazine
7. Operational Counter with reset
8. Fitting Sensor

2.3 Fitting Inserter Electrical

- Plug the electrical connector from the 24V DC into the back of the Automatic Fitting Inserter and plug the 24V power supply into an 110V AC outlet. **The smart relay**

inside the machine has an 8 second power up time before the Automatic Fitting Inserter becomes fully operational.

2.4 Pin Set Installation

NOTE: AIR SUPPLY MUST BE DISCONNECTED AND THE JAWS MUST BE IN THE CLOSED POSITION.

- To begin you must first clear the vibratory bowl track of any pre-loaded fittings.
- By hand run the fittings back up the Vibratory Bowl track and let the fittings fall back into the bowl.
- Loosen and remove the two (2) rail screws using a 3/16" hex wrench. *Figure 2.4.1 and 2.4.2.*
- Slide the fitting track towards the rear of the machine until it clears both dowel pins and carefully set the bowl track to the side. *Figure 2.4.3*



Figure 2.4.1

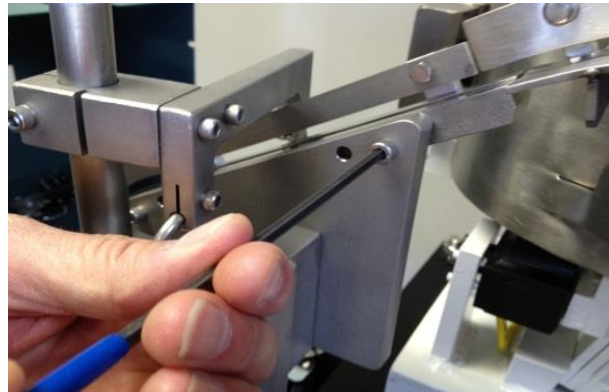

Figure 2.4.2

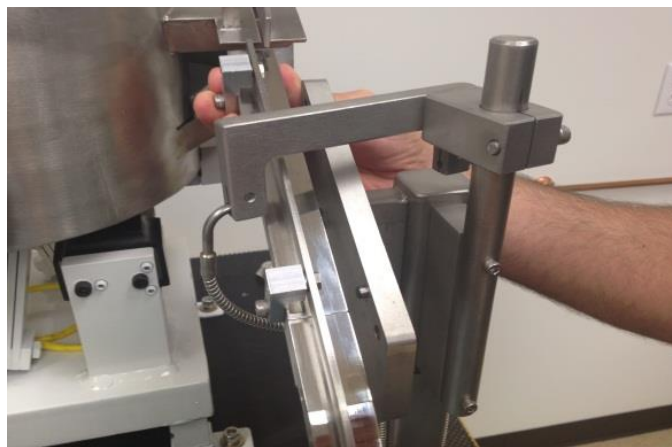

Figure 2.4.3

- If the mounting plate for the bowl track interferes with the cover of the machine, it will have to be removed before the cover can be removed from the machine.
- Locate the two (2) mounting screws for the bowl track mounting plate. *Figure 2.4.3.A* and remove them using a 3/16" hex wrench. *Figures 2.4.3.B & 2.4.3.C*

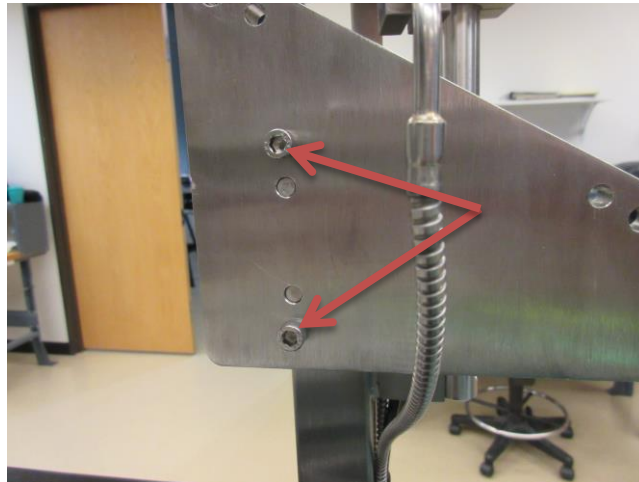

Figure 2.4.3.A



Figure 2.4.3.B

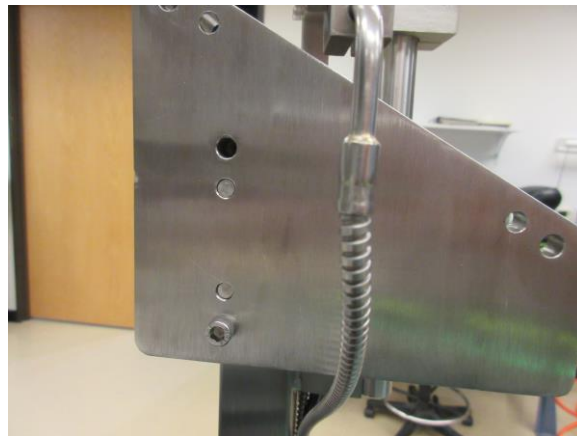

Figure 2.4.3.C

- After removing both screws, carefully pull the bowl track mounting plate towards the rear of the machine, being careful to avoid catching or damaging the sensor cables, and remove it from the dowel pins. *Figure 2.4.3.D* Set the mounting plate aside.



Figure 2.4.3.D

- Remove the magazine from the unit by pulling straight up. **Figure 2.4.4** Loosen the six (6) button head screws on both sides of the cover. Lift the cover up and carefully place on left side of base as wire and air lines are connected from the cover to the unit. **Figure 2.4.5**

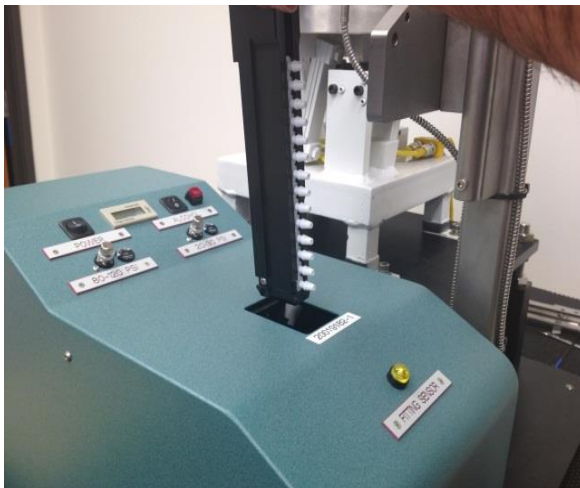

Figure 2.4.4

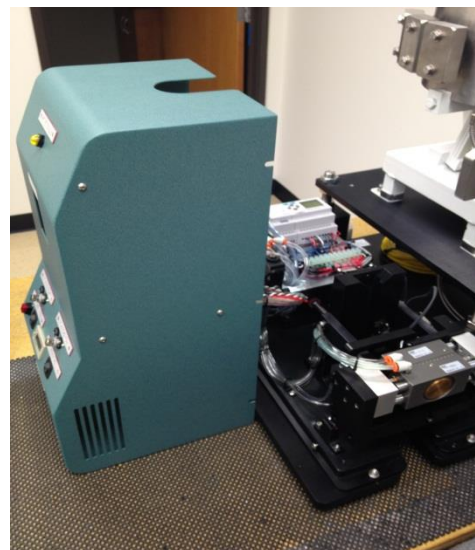

Figure 2.4.5

- The CRD600AF is equipped with a Pin Set Assembly which is designed for a specific tube fitting.
- Roll the pin on a flat surface to insure that it is straight.
- Insert the pin tip into the hole near the bottom of the magazine rack. Slide the pin through the hole until it is horizontal within the CRD600AF. **Figure 2.4.6**
- Push the pin toward the back of the unit until the threaded end reaches the threaded cylinder rod. Turn the pin clockwise to tighten.

- Once the pin is hand-tightened, pull the pin forward exposing the cylinder. **Figure 2.4.7**
Place a 7/16" open end wrench on the flats of the cylinder rod and hold in place.
- Place a 5/16" open end wrench onto the flats of the pin set and tighten pin set into the cylinder rod. **Figure 2.4.8**
- Manually pull the pin forward to ensure it goes through the magazine and into the jaw set.

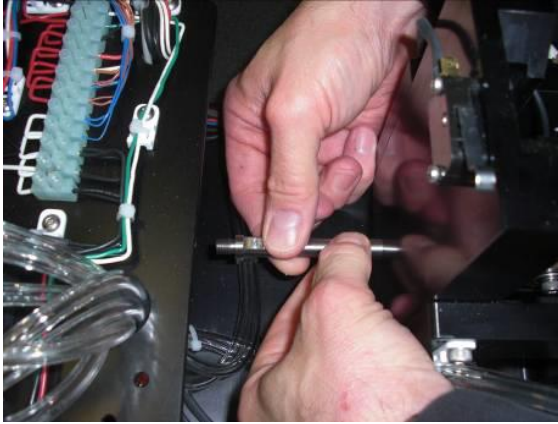

Figure 2.4.6
Aligning the pin

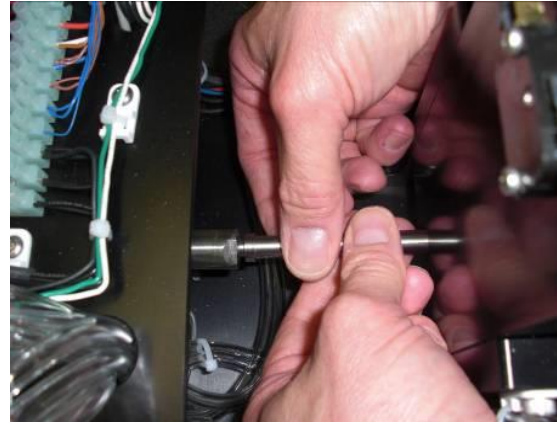

Figure 2.4.7
Threading pin to cylinder

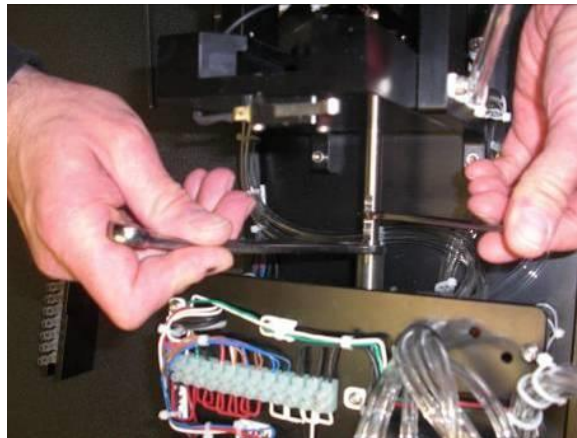

Figure 2.4.8
Tightening pin to cylinder

2.5 *Jaw Set Installation*

NOTE: AIR SUPPLY MUST BE DISCONNECTED AND THE JAWS MUST BE IN THE CLOSED POSITION.

- To begin you must first clear the vibratory bowl track of any pre-loaded fittings.
- By hand run the fittings back up the Vibratory Bowl track and let the fittings fall back into the bowl.

- With the cover off, using a 4mm hex wrench loosen the four 5mm screws holding the jaws into the block. *Figure 2.5.2*

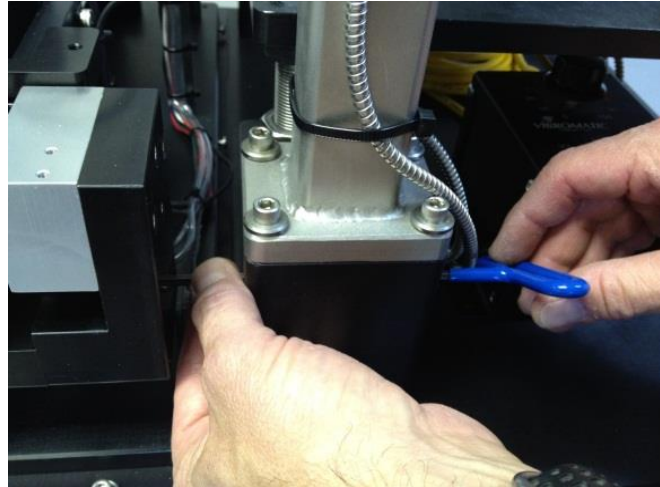

Figure 2.5.2

- Remove the jaws and replace with new set.
- Retighten the four 5mm screws using a 4mm hex wrench.
- **Check the pin-jaw alignment for pin concentricity.** With the air turned off and the magazine in, place a piece of tubing in the jaw set and clamp the tubing manually with the jaws. Pull the pin forward manually through the magazine and ensure that it lines up with the center of the inner diameter of the tubing. Gently rotate the pin to ensure that there is no wobble in the pin head. **Failure to do so may result in severe damage to both the magazine and jaw set!**
- If any wobble is detected, recheck that the tightness of the cylinder shaft and pin set. If there is still a wobble, the Pin Set Assembly is bad and another must be used.

2.6 *Adjusting the Stop Gate*

NOTE: AIR SUPPLY MUST BE DISCONNECTED AND THE JAWS MUST BE IN THE CLOSED POSITION PRIOR TO THIS ADJUSTMENT.

- The distance between the end of the jaw set and the stop gate may need to be adjusted according to what fitting is being used. This distance to adjust the stop gate is determined by the gap between the fitting flange and the end of the tubing. Sliding the stop gate away from the front of the unit will insert the fitting deeper into the tubing. *Figures 2.6.1 and 2.6.2* below show the tubing before adjusting the stop gate and after adjusting the stop gate.



Figure 2.6.1
Unadjusted Stop Gate



Figure 2.6.2
Adjusted Stop Gate

- To adjust this distance, loosen the one 5mm socket cap screw on the side of the gate and move the gate in or out depending on the stick out desired. **Figures 2.6.3 and 2.6.4** Re-tighten the screw before attempting to run the unit.

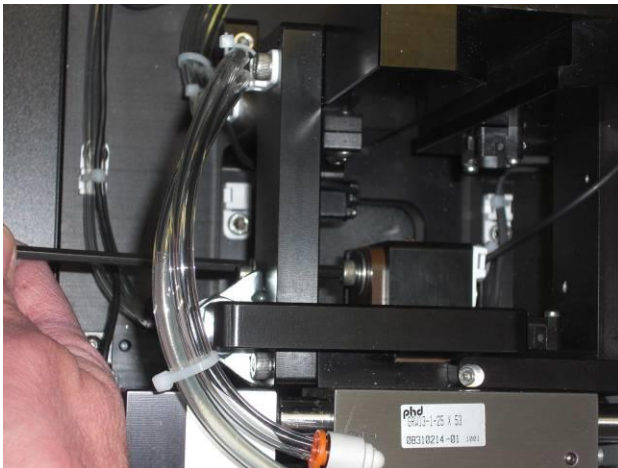

Figure 2.6.3
Loosening the socket head cap screw

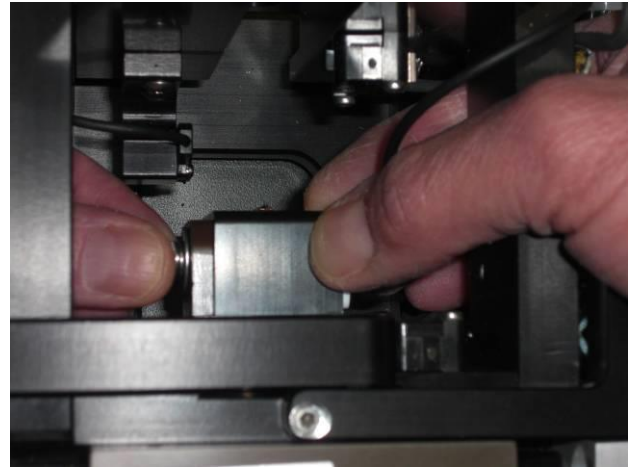

Figure 2.6.4
Sliding the gate forward

- If the fitting is not being fully inserted, adjust the gate backwards, towards the pin. If the fitting is being pushed on too far, or the tubing is rolling, adjust the gate forward, toward the operator. Verify that the tip of the pin set is well centered with the jaw set in both a left-to-right view point and an up-and-down view point.
- Close the Cover on the CRD600AF and tighten the five (5) button head screws on each side using a 3mm hex wrench.

2.7 Magazine Installation

- To begin you must first clear the vibratory bowl track of any pre-loaded fittings.
- By hand run the fittings back up the Vibratory Bowl track and let the fittings fall back into the bowl.
- Select the appropriate magazine that corresponds to the fitting being installed.
- Slide the fittings into the slot on the magazine so that the barbed end (the end you will insert into the tube) is protruding. Put enough parts into the magazine to fill it.
- **Always have at least five fittings in the magazine or a jam may occur.**
- Place the magazine into the magazine rack with the parts facing the jaw set.
- Check to see that the fittings have fully settled into the magazine.
- With the air turned off, pull the pin forward and verify the pin set enters the magazine and the fitting, and drives the fitting forward into the jaws.
- **Last Fitting Position Sensor** – If the lower-most fitting in the magazine is not seated correctly, the sensor will pick this up and the unit will not fire. This prevents the pin set from crashing into the last fitting and damaging the pin set or magazine.
- When no fitting is present or the fitting is not properly aligned, only the green ‘power on’ LED will be on and amber sensor LED will be off. **Figure 2.7.1**

If a fitting is properly seated in the magazine, the sensor will detect this and display an Amber LED as well as the single green ‘power on’ LED. Shown in the figures below is the sensor with and without fittings. **Figure 2.7.2**

THIS SENSOR’S POSITION IS A FACTORY SETTING, ANY ADJUSTMENT COULD CAUSE DAMAGE TO YOUR PIN SET, MAGAZINE OR JAW SET.

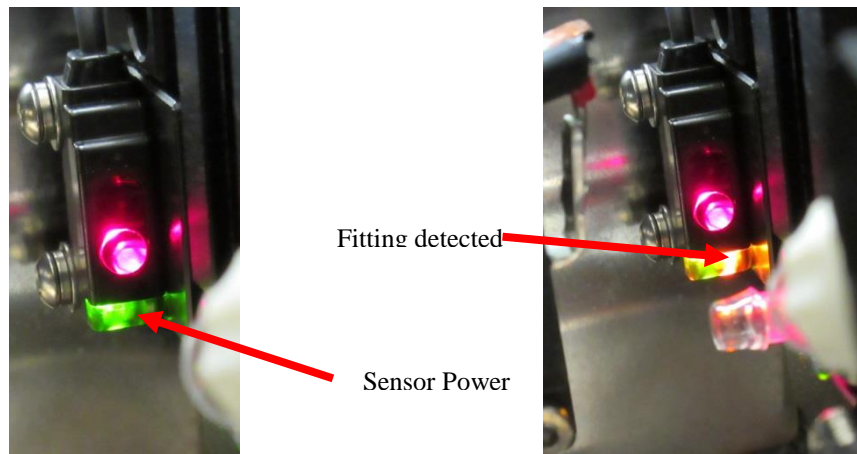

Figure 2.7.1
Sensor without fittings

Figure 2.7.2
Sensor with Fittings

Adjusting Last Fitting Sensor Position – By adjusting the sensor up or down, you can position the sensor properly. Using five (5) thin strips of paper, make a spacing gauge for the Last Fitting Sensor. (Figure 2.7.3)



Figure 2.7.3
5 strips of paper for gauge

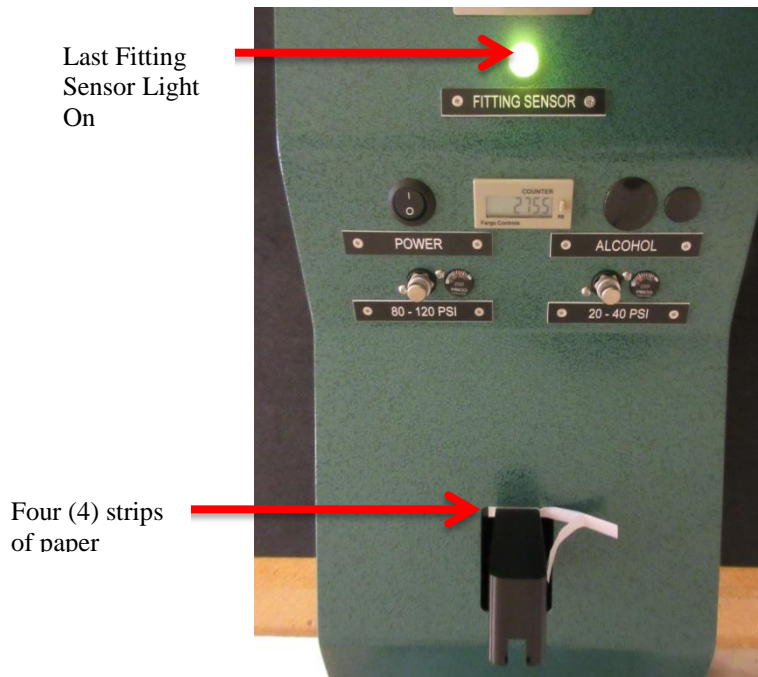

Figure 2.7.4
Verifying LFS light 'ON'

When four (4) strips of paper are inserted between the magazine and the top of the magazine rack, the Last Fitting Sensor light should be on. (Figure 2.7.4)

If the Last Fitting Sensor does not light with four (4) strips of paper, use a 3mm Metric Hex Wrench (T Handle preferred) to adjust the sensor position upwards (turn the adjustment screw clockwise) until the Last Fitting Sensor light turns on. (Figure 2.7.5 & 2.7.6)



Figure 2.7.5
Adjusting LFS position

Adjustment
Screw

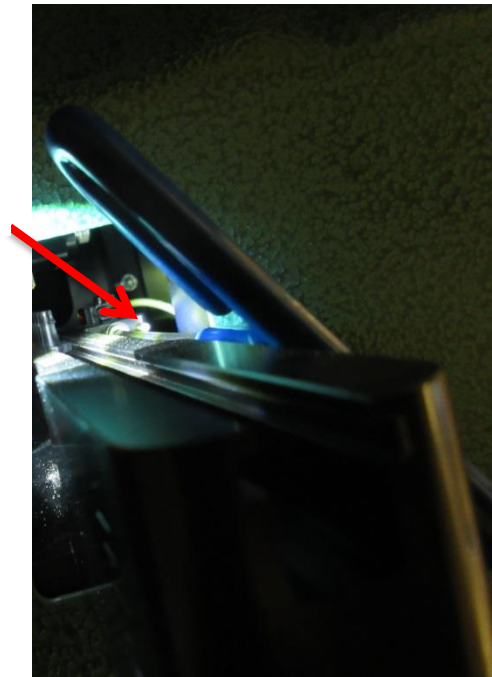

Figure 2.7.6
Adjustment Screw Detail

After verifying that the Last Fitting Sensor light is lit with four (4) pieces of paper, add the fifth strip of paper between the magazine and the top of the magazine rack. (Figure 2.7.7)

The Last Fitting Sensor light should go out. If the light goes out, press firmly on the top of the magazine as shown (Figure 2.7.8) to check if the light will come back on.



Last Fitting
Sensor Light
Off

Five strips
of paper

Figure 2.7.7
Five strips of paper as gauge



Figure 2.7.8
Pressing firmly on magazine

If the Last Fitting Sensor light remains lit with five (5) strips of paper between the magazine and the top of the magazine rack, adjust the sensor downward (turning the adjustment screw counter-clockwise) until the light goes out, then return to the previous steps detailing figures 2.7.4 – 2.7.6.

Once the Last Fitting Sensor is adjusted properly, it will remain lit with four (4) pieces of paper (Figure 2.7.4) and turn off with five (5) pieces of paper (Figure 2.7.7).

3.0 Operation

3.1 Loading Magazine and Jaws

- **Hook up the air FIRST and then turn on the power**
- Fill the magazine with fittings (5 minimum)
- Insert a tube into the jaws, pushing forward until gate switch is hit.
- Unit will cycle pushing the fitting into tube and then dropping the assembly down

3.2 Fitting Sensor Lamp

- Yellow lamp is always on when machine is operating. If lamp is out it indicates that the magazine is empty of fittings or the fitting is not all the way down in the proper position in the magazine.

3.3 Vibromatic Controller

- With the controller in the “OFF” position ensure the Force dial is set to 80. Setting the Force dial any faster can cause the Vibratory Bowl to improperly load and supply the magazine. You can now switch the controller to the “ON” position. **Figure 3.3.1**



Figure 3.3.1

4.0 Removing Fitting Inserter from Vibratory Base

4.1 Clearing Vibratory Bowl Track and Separating Fitting Inserter

- To begin you must first clear the vibratory bowl track of any pre-loaded fittings.
- By hand run the fittings back up the Vibratory Bowl track and let the fittings fall back into the bowl.
- Loosen and remove the two (2) rail screws using a 3/16" hex wrench. **Figure 4.1.1 and 4.1.2.**
- Slide the fitting track towards the rear of the machine until it clears both dowel pins and carefully set the bowl track to the side. **Figure 4.1.3**

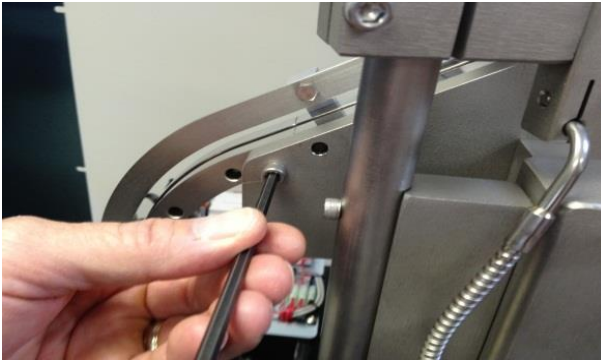

Figure 4.1.1

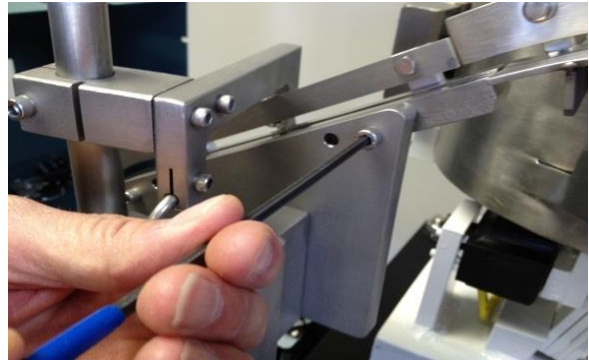

Figure 4.1.2

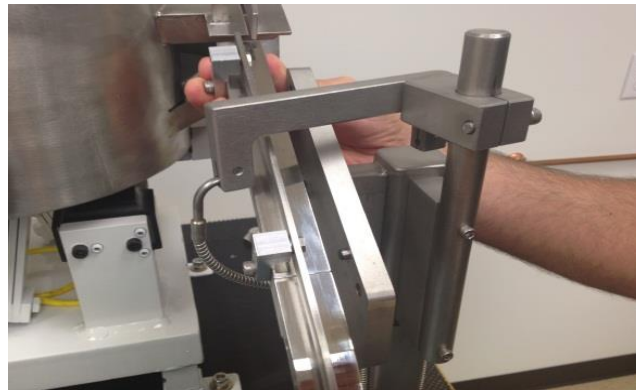

Figure 4.1.3

- If the mounting plate for the bowl track interferes with the cover of the machine, it will have to be removed before the cover can be removed from the machine.
- Locate the two (2) mounting screws for the bowl track mounting plate. **Figure 4.1.3.A** and remove them using a 3/16" hex wrench. **Figures 4.1.3.B & 4.1.3.C**

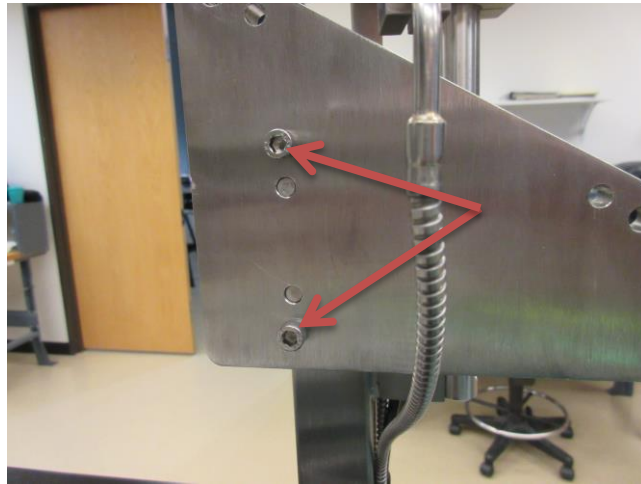

Figure 4.1.3.A



Figure 4.1.3.B

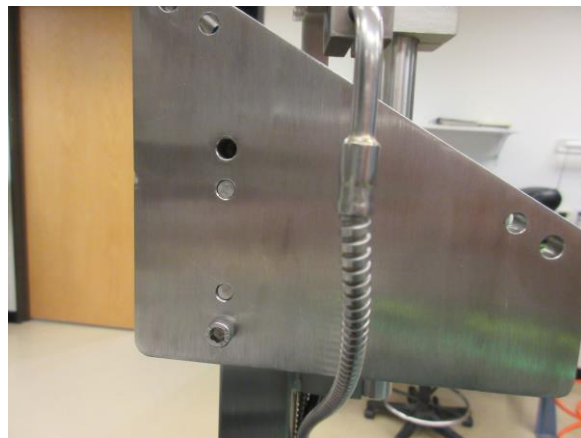

Figure 4.1.3.C

- After removing both screws, carefully pull the bowl track mounting plate towards the rear of the machine, being careful to avoid catching or damaging the sensor cables, and remove it from the dowel pins. *Figure 4.1.3.D* Set the mounting plate aside.

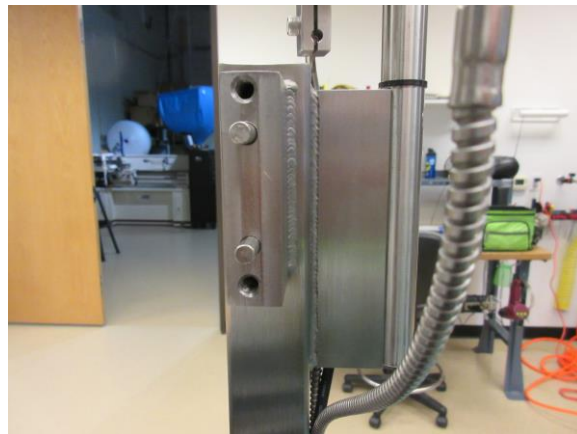

Figure 4.1.3.D

- Remove the magazine from the unit by pulling straight up and carefully place it to the side.
- Remove the four (4) 10-32 socket cap screws located on the front and rear of the machine using a 5/32" hex wrench. *Figure 4.1.4*



Figure 4.1.4

- With the four (4) screws removed you can now lift evenly from the front and rear of the machine until you clear the two (2) dowel pins located in the front and rear of the Vibratory base. *Figure 4.1.5*

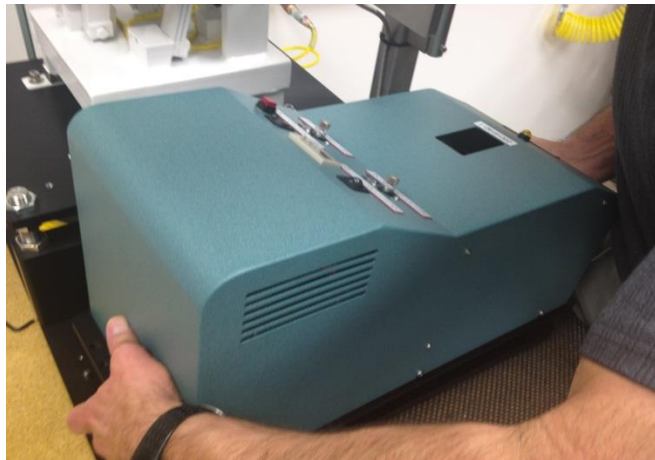

Figure 4.1.5

5.0 Maintenance

5.1 Daily

- **Once each day:** the pin set should be retightened onto the air cylinder. Loose pin sets can result in damage to the unit.

- **Once each day:** ensure that the screws holding the jaws on are tight. Loose screws will allow the jaws to move enough that fittings may not properly insert into the tubing.
- **Once each day:** disconnect the air at the rear of the unit and pull the pin set toward the magazine hole and be sure that it enters the hole freely (without hanging up on the side-wall). The pin set must enter the magazine hole without moving the magazine or damage can occur.
- The bowl should be wiped clean before loading fittings into it.

5.2 *Every three months*

- **Once every three months,** the lid should be opened and the inside around the jaw set and magazine should be cleaned via air (no more than 30psi). This will remove any dust that has collected. At this time, air connectors on the manifold should be checked for tightness. The pin-set should be checked to make sure it is tight. Any dust or debris which the blown air did not clean up should be wiped away.
- Wipe down outer surfaces of Fitting Inserter and Vibratory Bowl with alcohol, septihol or mild detergents as required.
- Check the rail screws for tightness on the Vibratory Bowl track.

6.0 **Recommended Spare Parts**

It is strongly recommended that you keep at least the following components on-hand to minimize downtime should a component wear out or break.

- 1 additional Pin Set Assembly
- 1 additional Magazine
- 1 additional Jaw Set

7.0 **Product Specifications**

Unit Weight	202 LBS / 91.62 KG
Overall Dimensions	25.5 in. (64.7cm) lg. x 21.5 in. (54.61cm) w. x 23.25 in. (59.05cm) ht.
Minimum/Maximum PSI	100 PSI /120 PSI

8.0 Trouble Shooting

Operating Error	Action
Unit does not operate.	<ol style="list-style-type: none"> 1. Check the facility air connection. 2. Check both regulators are set to the proper pressure 3. Check electrical power, 110VAC & 24 VDC 4. Check all safeties: <ul style="list-style-type: none"> • Cover switch-make sure cover is completely on • Magazine switch-make sure magazine is pushed down all the way in the magazine rack • Last fitting sensor- verify last fitting is in position
Tubing does not go on the fitting / all the way on.	<ol style="list-style-type: none"> 1. Adjust Stop Gate position 2. Adjust high pressure, should be 80-120 psi.
Fittings do not move in bowl	<ol style="list-style-type: none"> 1. Check power setting switch 2. Check Vibratory Force Dial setting
Fittings are sticking in track	<ol style="list-style-type: none"> 1. Check the rail screws for tightness 2. Check the plastic flash on the fitting

9.0 Durometer Scale

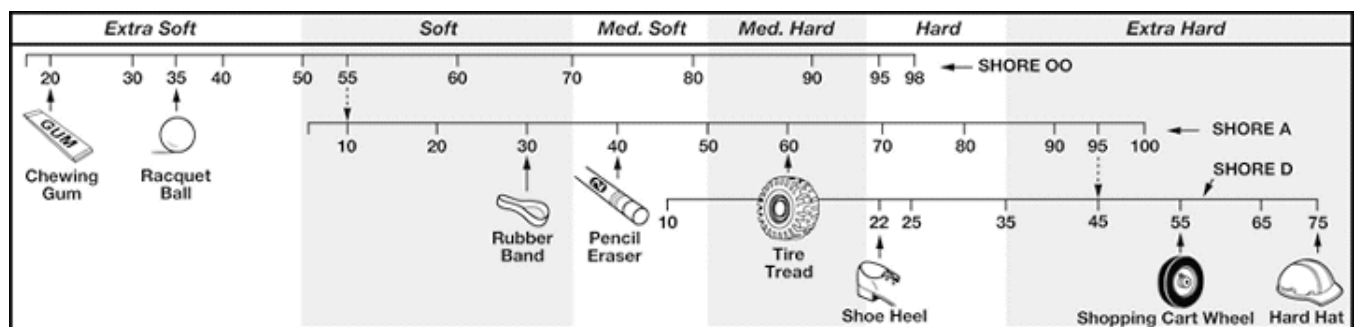

10.0 Electrical & Pneumatic Diagrams

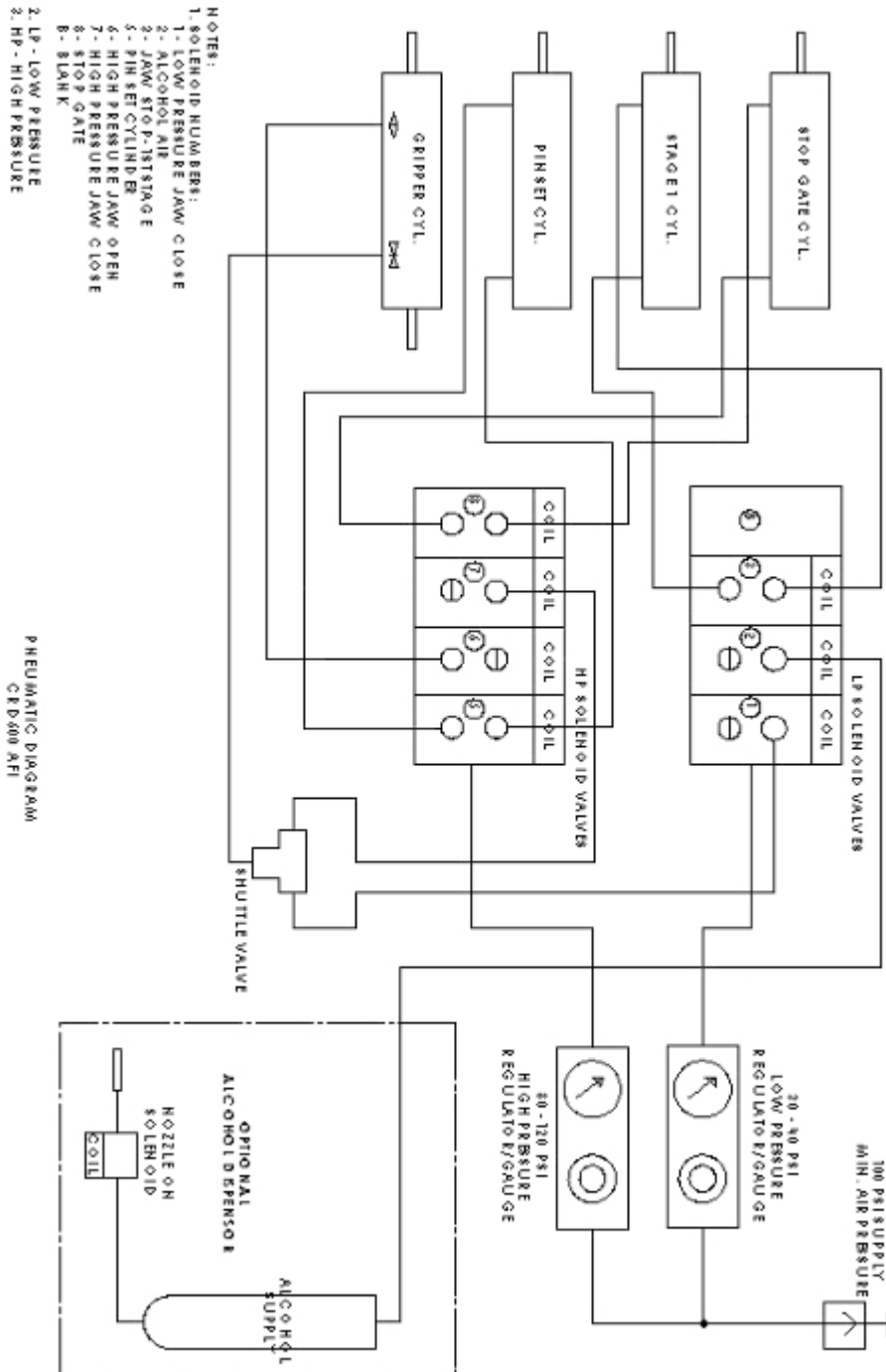

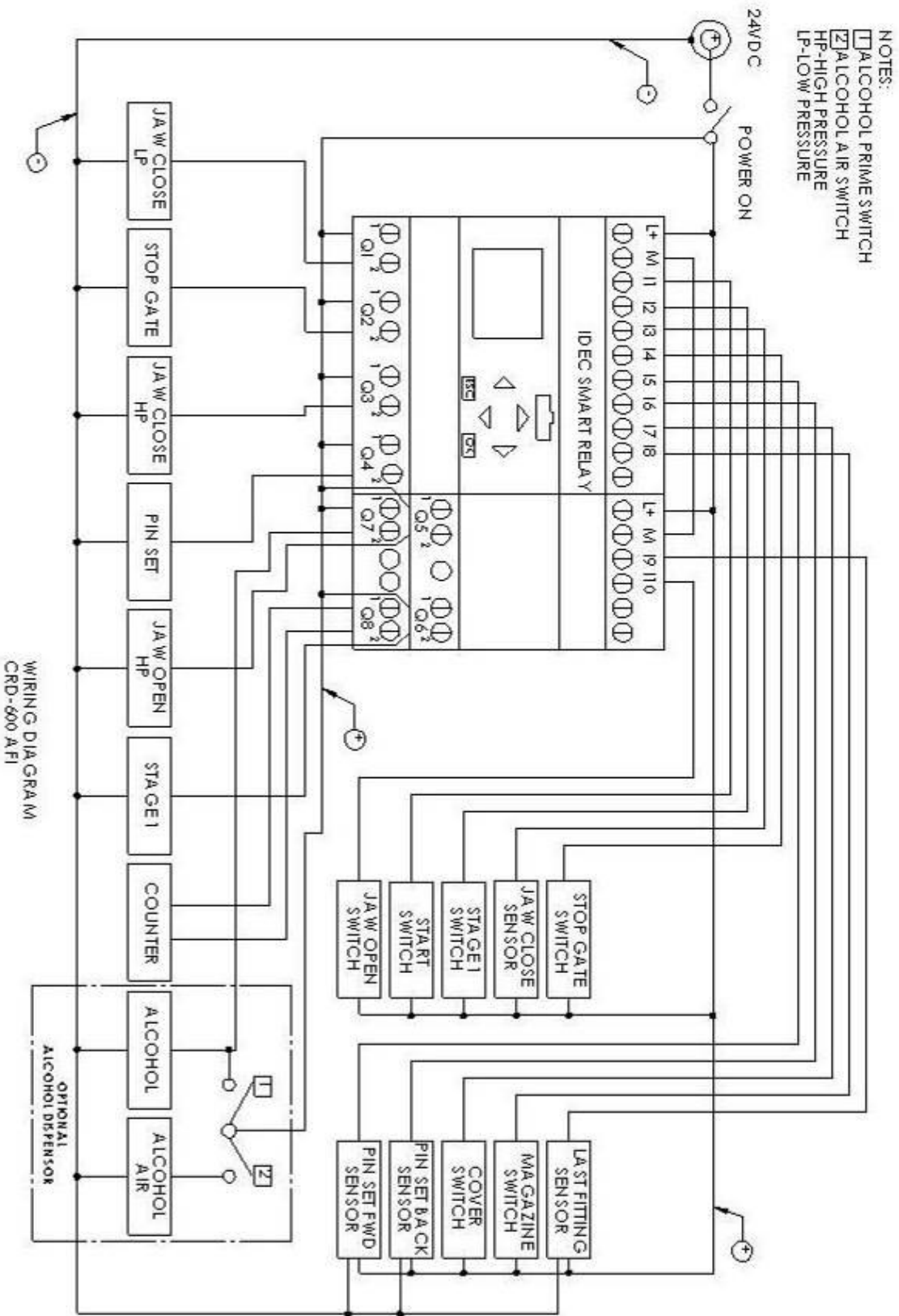

WIRING DIAGRAM
CRD-600 AFI

11.0 Vibratory Hopper Option

The Vibratory Hopper allows the CRD600AF to be loaded with fitting more efficiently and ensures that the machine can operate for much longer periods before requiring reloading.

IMPORTANT: READ BEFORE INSTALLING THE VIBRATORY HOPPER

Mounting the Vibratory Hopper to the CRD600AF

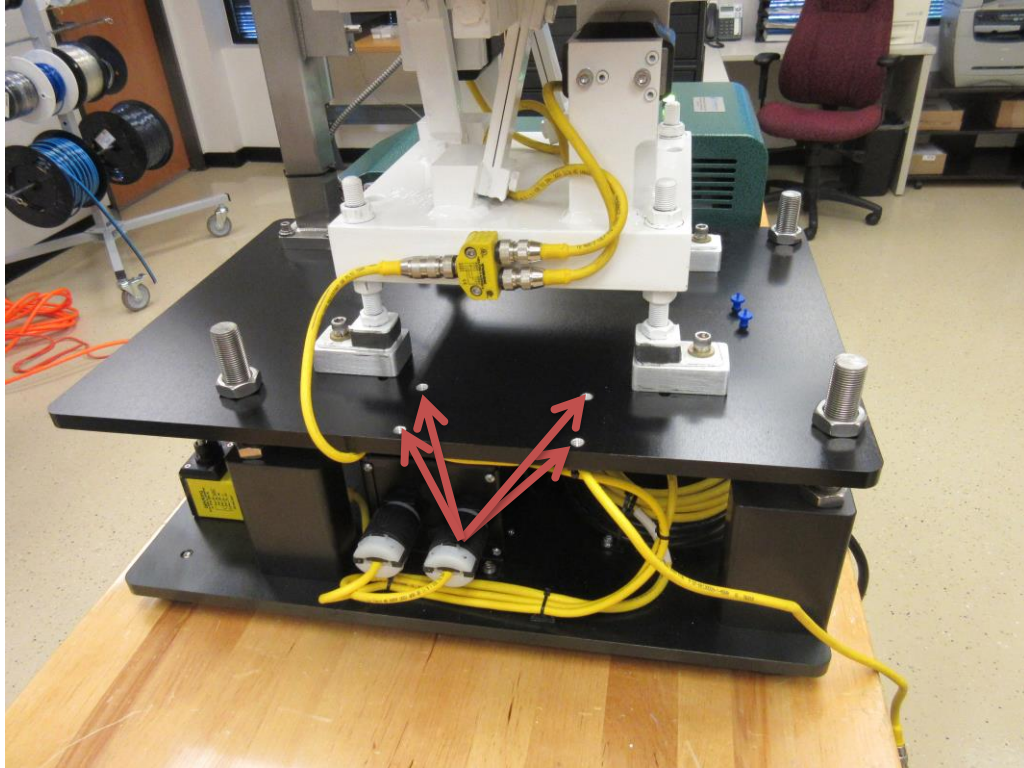

There are four (4) mounting holes located on the right (as you face the machine) side of the upper plate. Locate the four (4) mounting screws that are packaged with the hopper.

NOTE: INSTALLING THE HOPPER IS BEST PERFORMED USING TWO (2) PEOPLE FOR SAFETY.

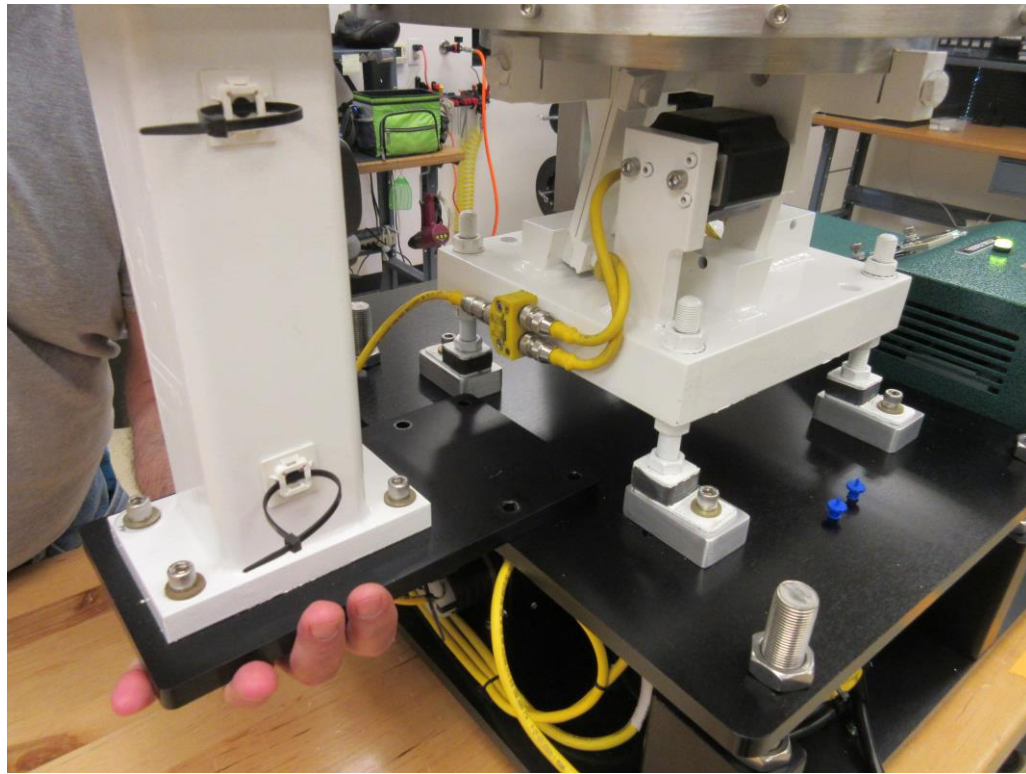

Have one person hold the hopper in place while the second person installs the mounting screws using a 1/4" hex wrench.

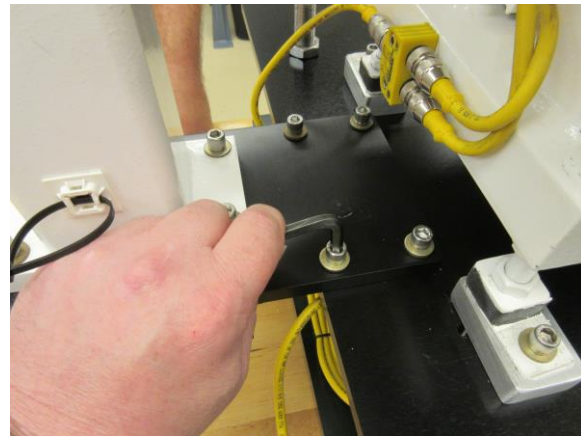
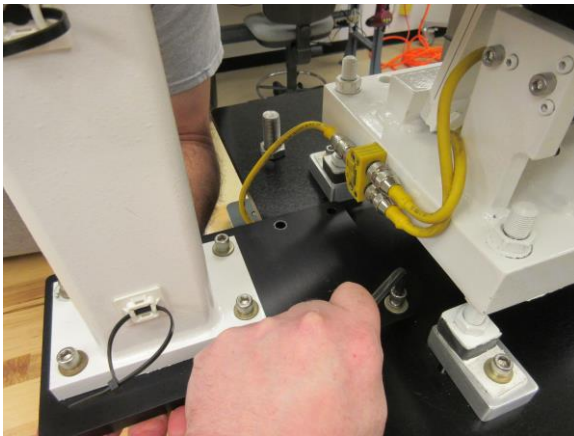

Make sure all four (4) mounting screws include the brass flat washer and lock washer. Fully tighten all four (4) screws to secure the hopper to the Vibratory Bowl Mounting Plate.

Once the Vibratory Hopper is mounted, route the yellow cable through the three (3) wire ties. The first wire tie is located on the bottom of the Hopper extension plate.

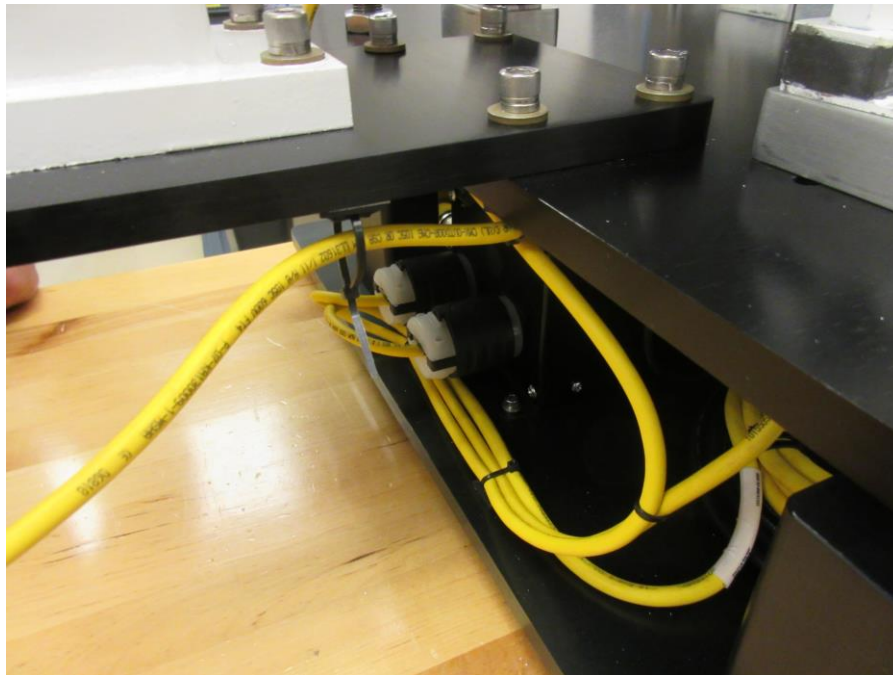

The final pair are located on the back of the Vibratory Hopper post.

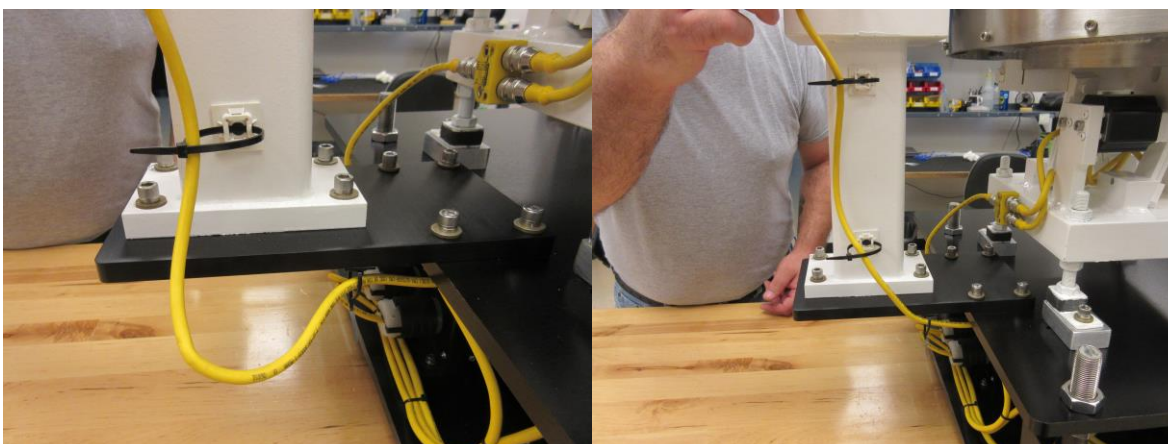

Once the cable has been threaded through the loose wire ties, align the key of the cable with the side attached to the hopper and hand tighten.

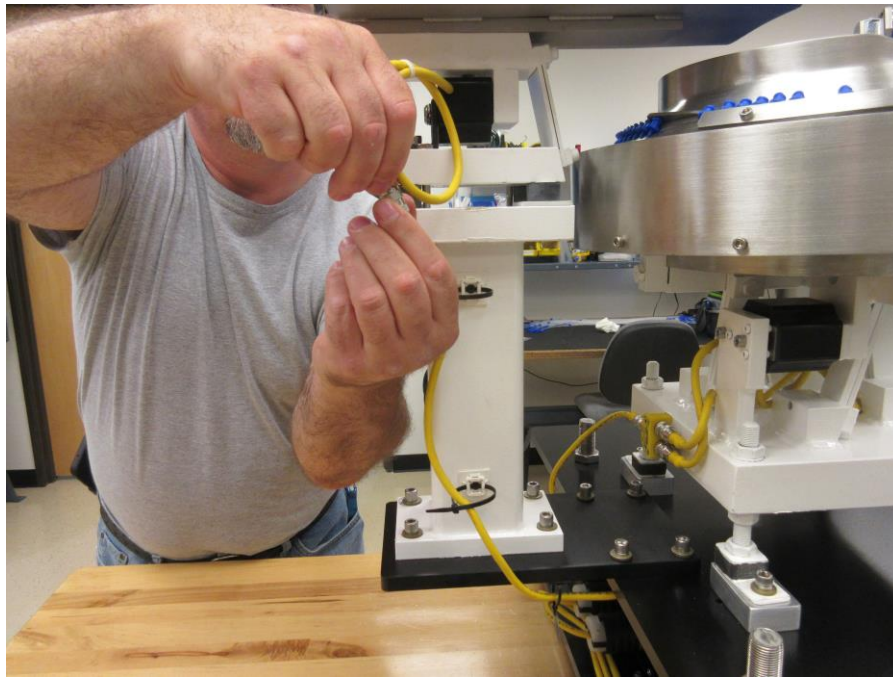

Once both ends of the cable are connected, tighten the wire ties to hold the cable in place and clip off the remainder.

12.0 Alcohol Dispenser Option

The Alcohol Dispenser allows lubrication to be placed on the barb directly, allowing for a more reliable fitting insertion process. Shown are both the assembly instructions, as well as how to fill and refill the reservoirs.

IMPORTANT: READ BEFORE OPERATING ALCOHOL DISPENSER

Attaching Alcohol Reservoir to CRD600



Air into Vessel 

Fluid return from Vessel 



Filling Alcohol Reservoir:



Step 1



Step 2



Step 3

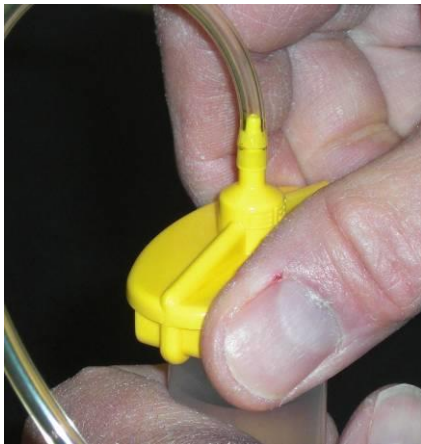

Step 4



Step 5



Step 6

Step 1 – Disconnect air with quick-disconnect

Step 2 – Twist open the barrel assembly

Step 3 – Fill reservoir with alcohol

Step 4 – Reconnect barrel assembly

Step 5 – Reconnect quick-disconnect

Step 6 – Prime alcohol system by pressing the red button switch on the CRD600 cover

Use adjustment knob on regulator to set pressure to 20-30 psi for the CRD600AF unit. The alcohol is controlled by the low pressure regulator.

Caution: Setting the regulator pressure above 30 psi will result in pressure relief valve opening.

DO NOT BYPASS RELIEF VALVE

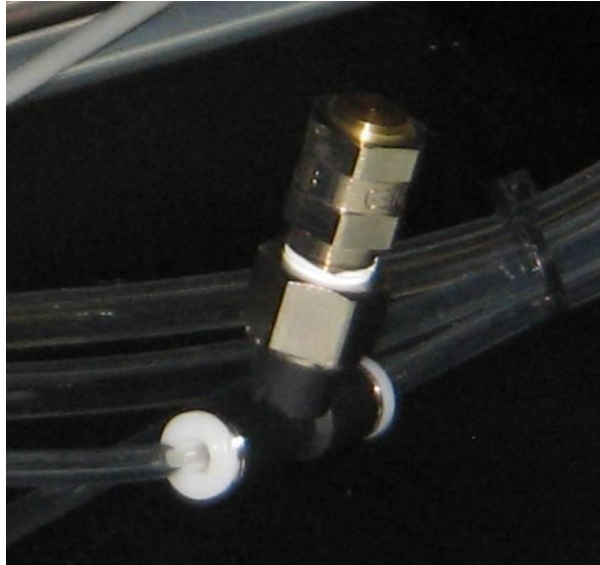

Alcohol Dispenser Relief Valve

Aiming the Alcohol Dispenser Nozzle:

Accurate aiming of the dispenser nozzle is critical to ensuring proper performance. Adjust the alcohol dispenser nozzle 1/16 – 1/8 of an inch in from the front of the barb, and at an oblique angle as shown in the diagram below. This alignment will ensure that alcohol will flow around both sides of the barb.

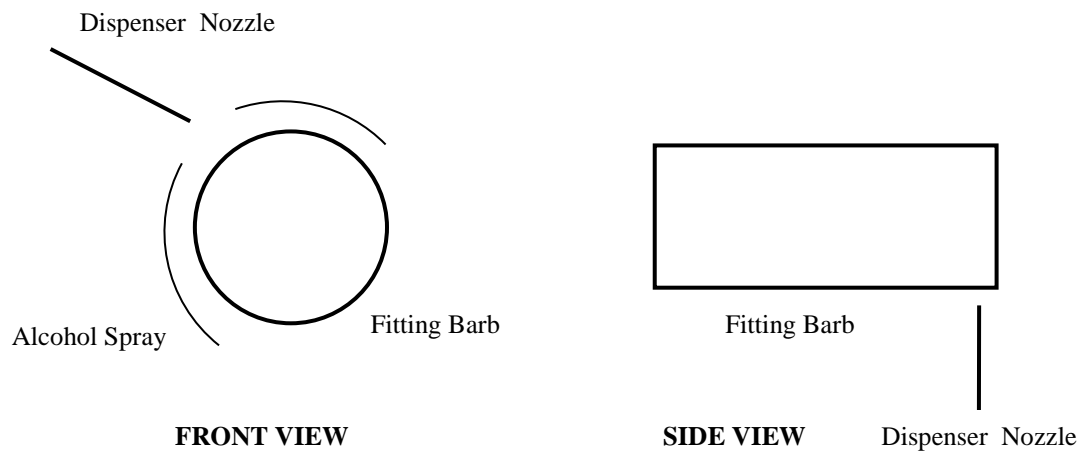

Proper latching of high capacity reservoir:

Align the arrows on the cap and body of the high capacity reservoir to ensure proper pressurization and functionality of alcohol dispenser.

WARNING: Failure to lock reservoir can result in malfunction of equipment and personal injury.



Reservoir in locked position



Reservoir in unlocked position

Attach large reservoir to CRD600AF by following the same instructions for the small capacity reservoir as shown above on previous pages.

13.0 Warranty

13.1 Warranty

The manufacturer warrants the product manufactured by it, when properly installed, operated, applied and maintained in accordance with the procedures and recommendations outlined in the manufacturer's operation manual, to be free from defects in material or workmanship for a period as specified below, provided such defect is discovered and brought to the manufacturer's attention within the stated warranty period.

The manufacturer will repair or replace any product or part determined to be defective by the manufacturer within the warranty period, provided such defect occurred in the normal service and not as a result of misuse, abuse, neglect or accident. Normal maintenance items requiring routine replacement are not warranted. The warranty covers parts and labor for the warranty period unless otherwise specified. Repair or replacement shall be made at the factory or the installation site, at the sole discretion of the manufacturer. Any service performed on the product by anyone other than the manufacturer must first be authorized by the manufacturer.

Unauthorized service voids the warranty and any resulting charge or subsequent claim will not be paid. Products repaired or replaced under warranty shall be warranted for the unexpired portion of the warranty applying to the original product.

The foregoing is the exclusive remedy of any buyer of the manufacturer's product. The maximum damages liability for the manufacturer is the original purchase price of the product or part.

THE FOREGOING WARRANTY IS EXCLUSIVE AND IN LIEU OF ALL OTHER WARRANTIES, WHETHER WRITTEN, ORAL, OR STATUTORY, AND IS EXPRESSLY IN LIEU OF THE IMPLIED WARRANTY OF MERCHANTABILITY AND THE IMPLIED WARRANTY OF FITNESS FOR A PARTICULAR PURPOSE. THE MANUFACTURER SHALL NOT BE LIABLE FOR LOSS OR DAMAGE BY REASON OF STRICT LIABILITY IN TORT OR ITS NEGLIGENCE IN WHATEVER MANNER INCLUDING DESIGN, MANUFACTURE OR INSPECTION OR THE EQUIPMENT OR ITS FAILURE TO DISCOVER, REPORT, REPAIR, OR MODIFY LATENT DEFECTS INHERENT THEREIN.

THE MANUFACTURER, HIS REPRESENTATIVE OR DISTRIBUTOR SHALL NOT BE LIABLE FOR LOSS OF USE OF THE PRODUCT OR OTHER INCIDENTAL OR CONSEQUENTIAL COSTS, EXPENSES, OR DAMAGES INCURRED BY THE BUYER, WHETHER ARISING FROM BREACH OF WARRANTY, NEGLIGENCE OR STRICT LIABILITY IN TORT.

The manufacturer does not warrant any product, part, material, component, or accessory manufactured by others and sold or supplied in connection with the sale of manufacturer's products.

13.2 Warranty Period

Parts and labor are for ninety (90) days from the date of shipment from the factory. Freight to the factory on units that the manufacturer requests to be returned shall be paid by the purchaser, all return freight to be paid by the manufacturer; means of transportation to be specified by the manufacturer.

For additional information contact: www.cleanroomdevices.com

Clean Room Devices, Inc.
10855 Dover Street, Suite 100
Westminster, CO 80021
303-438-0853