

 **CLEAN ROOM DEVICES, INC.**

# **CRD222 HEAVY-DUTY AUTOMATIC TUBING EXPANDER**

OPERATIONS MANUAL

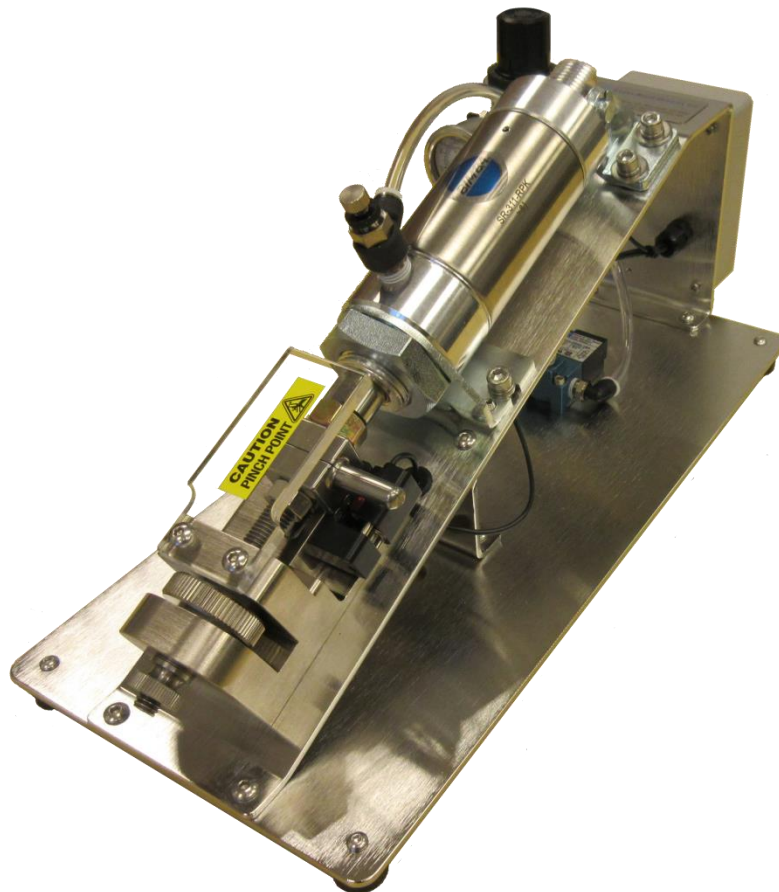

VERSION 2.3  
LAST EDITED 05.03.2021  
*cleanroomdevices.com*

# Table of Contents

- Title Page.....1
- Table of Contents.....2
- 1.0 General Product & Safety Information.....3
  - 1.1 Product Information
  - 1.2 Safety Information
- 2.0 Installation.....3
  - 2.1 Air Supply
  - 2.2 Electrical
  - 2.3 Connection Setup
- 3.0 Operation.....4
  - 3.1 Tube Expanding
  - 3.2 Setting the Time Delays
  - 3.3 Expanding Operation
  - 3.4 Replacing Jaws
- 4.0 Troubleshooting.....10
- 5.0 Maintenance.....11
  - 5.1 Periodic Cleaning (annually)
- 6.0 Product Specifications.....11
- 7.0 Durometer Scale.....11
- 8.0 Wiring Diagram.....12
- 9.0 Warranty.....13
  - 9.1 Warranty
  - 9.2 Warranty period

## 1.0 General Product & Safety Information

### 1.1 Product Information

- Unit is designed to expand flexible tubing up to a durometer of Shore A 85 (Shore D 35), including any non-metallic braided materials
- The minimum/maximum inside tube diameter is 7/16" – 3/4"
- The expander jaws are universal in design to meet most applications
- The unit design allows for simple operator adjustment

### 1.2 Safety Information

- This product uses an air cylinder and sensor or foot pedal to pneumatically actuate the expanding jaws. The unit is not intended to expand anything other than flexible tubing.

**WARNING**

**Avoid placing your fingers between the upper jaw block and the air cylinder mounting bracket while operating unit, sufficient pressure exists to cause personal injury.**

- The air supply should be free of moisture/contaminates, and set to a minimum of 100 psi. It is recommended that a suitable filter/regulator be installed onto the supply line prior to the unit to preserve the life expectancy of the air components.

## 2.0 Installation

Ensure all five (5) rubber feet are completely stabilized on your work surface prior to applying air pressure to the unit.

### 2.1 Air Supply

- Connect a 1/4" air supply hose to the inlet on the pressure regulator. The air supply should be free of moisture and contaminants and provide a minimum of 100 psi.
- The regulator on the unit should be set to 80-120 psi.

### 2.2 Electrical

- 120 to 240V AC power supply required for operation. The unit will come with the appropriate power supply.

## 2.3 Connection Setup

Setting up the connections on the CRD222 is a simple task. Please reference figure 2 below when making all connections to the back panel:

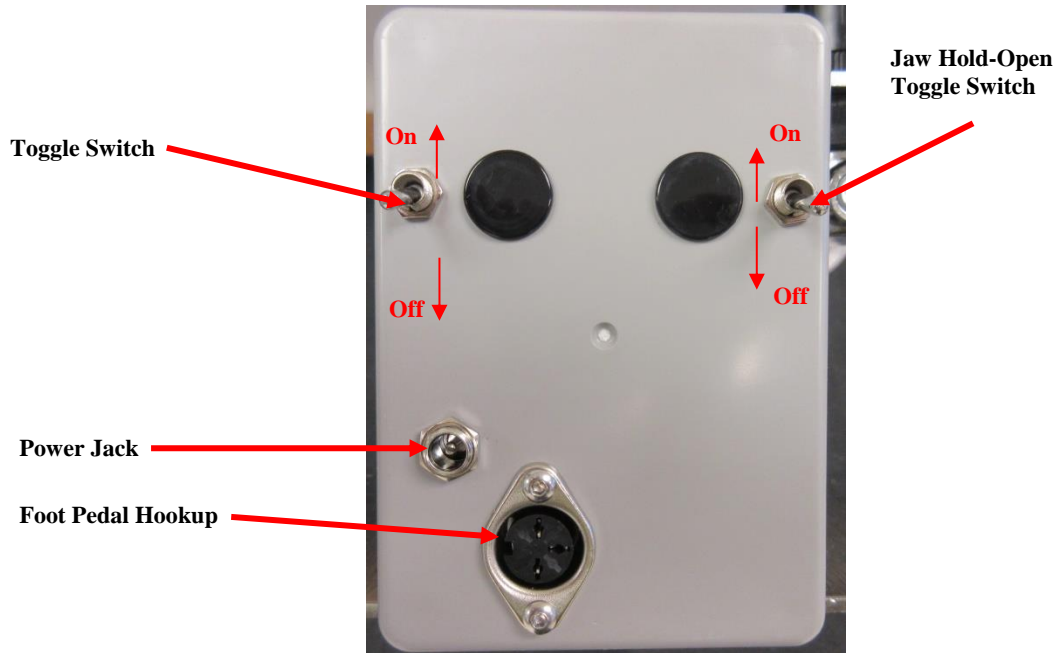

Figure 2: Electronics enclosure connections

## 3.0 Operation

### 3.1 Jaw Adjustment

- Start by using a 9/16" wrench to loosen the 3/8" hex nut at the bottom end of the lower jaw support block assembly to adjust the unit for the proper tubing size.
- Locate the lower expander jaw position for your tubing size using the larger *thumb-wheel*.

(This adjustment may require fine tuning depending on your tubing I.D., O.D., Durometer or material. It is recommended you note or log the jaw gap settings for future applications, or usage.)

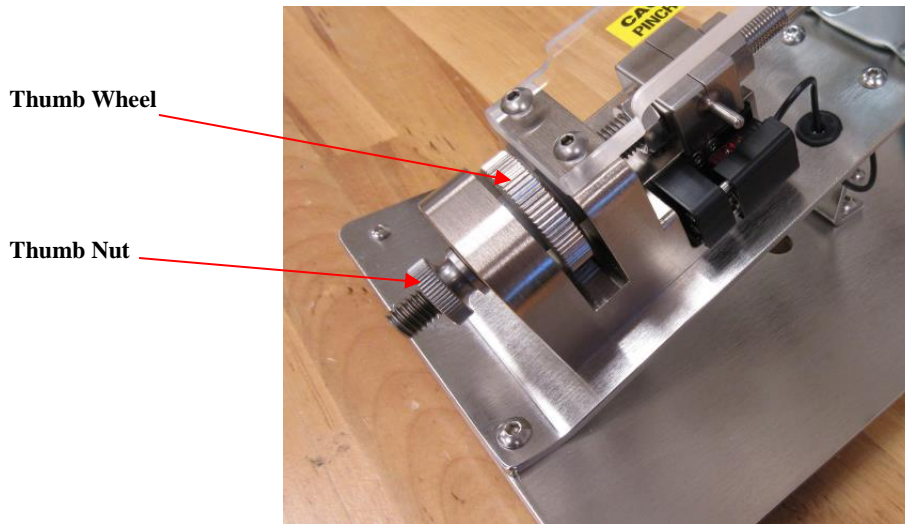

**Figure 1: Jaw Adjustment**

- Next, tighten the *thumb-wheel* against the lower mounting block and secure in place using the 9/16” wrench to snug the 3/8” hex nut against the bottom of the lower jaw support block assembly. Be careful that you do not over tighten the nut.

### 3.2 *Setting the Time Delays*

- The CRD222 expansion operation is designed to expand each piece of tubing twice. After the first expansion, the jaws will close and the operator rotates the tube 90 degrees and the jaws will automatically expand again using the sensor. This ensures that the tubing is expanded in a uniform fashion, and not deformed in only one direction. To assist with this 2-step expansion operation, there are 2 time delays on the unit.
  - **Expansion Time** – This setting adjusts the rate (0.5-5.0 seconds) at which the tube expansion occurs. The rate at which the tube is expanded is critical to prevent tearing. Some stiffer tubing might need a longer expansion time, while softer tubing can be expanded rapidly.
  - **Interval Time** – This setting adjusts the time delay rate (0.5-5.0 seconds) at which the jaws will cycle. It is adjusted to allow the operator to rotate the tubing 90 degrees at a comfortable pace between expanding.
- Remove the hole plugs with a screwdriver on the rear cover to gain access to the Time Delay adjustment pots.



**Figure 3: Removing Access Hole Plugs**

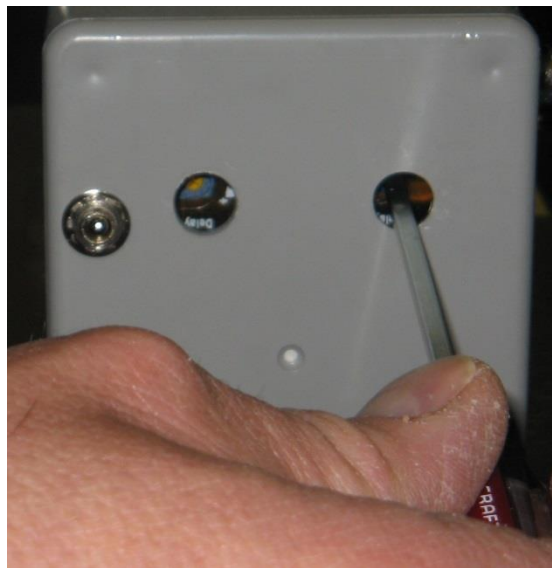

**Figure 4: Adjusting the Expansion Time pot**

- Using a small Phillips drive screwdriver adjust the Time Delay relays.



- Figure 5 below shows the CRD222 with the rear cover removed, as well as the location of both time delay adjustments on the time delay relay:



Figure 5: Time Delay Relay and Time Adjustments

### 3.3 Expanding Operation

- The CRD222 is designed to be used with a photo-sensor that will automatically sense the presence of tubing over the jaws. The sensor is aligned against the tangent of the jaw as shown in figure 6 below:

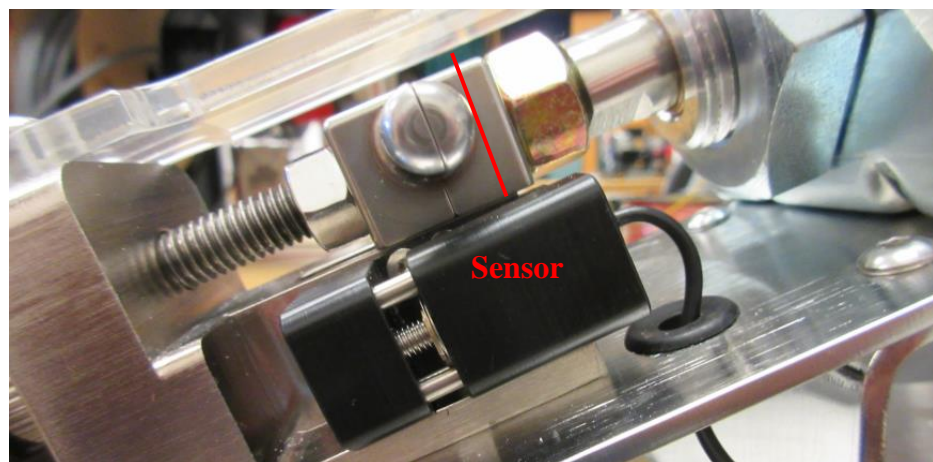

Figure 6: Photo-sensor line of sight

- Place the desired tubing over the ends of **both** expander jaws at the required depth.

- Once the tube is placed over the jaw, the jaws will expand at a rate determined by the expansion time setting.
- The jaws will then close and the operator will rotate the tubing 90 degrees. **Failure to do so may result in uneven expansion and/or damaged tubing!**
- After the interval time has expired, the jaws will then perform their second expansion operation, again at the appropriate expansion time.
- The jaws will then close a second time, and the machine cycle will be complete.
- If adjustment of sensor position is desired, use a 3mm hex wrench to turn the adjustment screw shown below in figure 7. Turning the sensor adjustment screw clockwise will move the sensor line closer to the jaws, while counterclockwise moves the sensor line away from the jaws.

Sensor Adjustment Screw

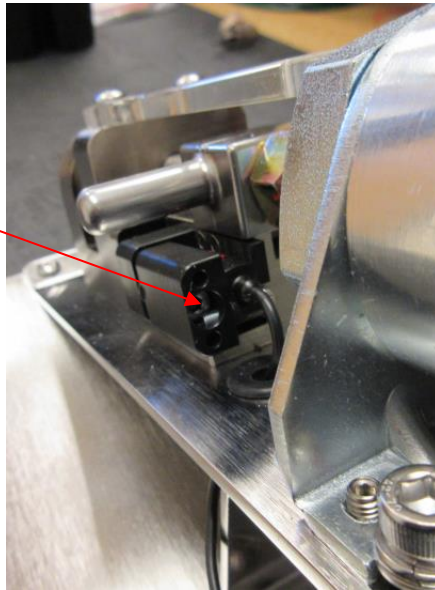

Figure 7: Sensor Adjustment Screw

- To operate the foot switch (optional), turn the switch on the rear cover to the down position and plug the pedal into the foot switch jack.

### 3.4 Replacing Jaws

- Remove the two front cylinder bracket screws with a 5mm hex wrench and rotate the cylinder up. (Fig 8,9)
- Loosen the jam nut holding the upper jaw by holding the flat of the cylinder shaft with a 1/2" wrench and turning the hex nut with a 3/4" wrench. Rotate the jaw counterclockwise to remove it from the shaft. (Fig 10)



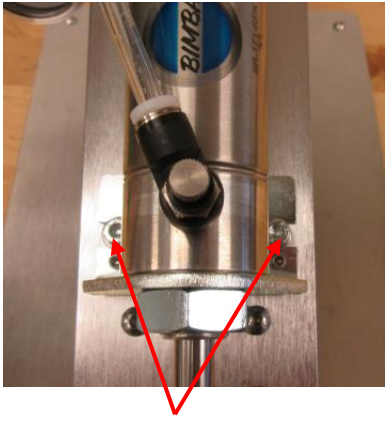

Figure 8: Front cylinder bracket screws

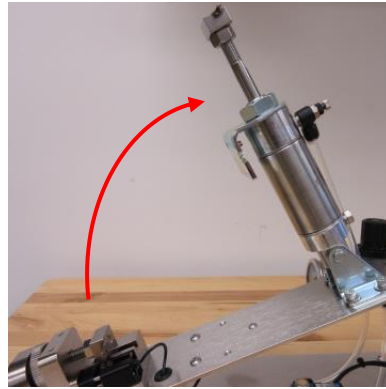

Figure 9: Rotate cylinder up

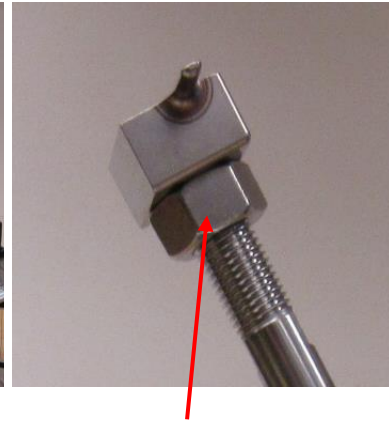

Figure 10: Jam nut

- Thread the replacement jaw onto the cylinder shaft by turning it clockwise. Make sure you only thread the jaw 1/2 to 2/3 of the way onto the shaft; this helps make sure the jaw will not pull off the lower jaw support block when the unit is activated. Secure jam nut.
- **Important note: when threading upper jaw on, only thread the jaw 1/2 to 2/3 of the way onto the cylinder shaft threads. Any further and it could slip off jaw block when cylinder is retracted causing a jam. (Fig 11,12)**



Figure 11: Jaw threaded 1/2-2/3 onto shaft



Figure 12: Jaw threaded on too far and has slipped off jaw block

- Using a 3mm hex wrench to turn the sensor adjustment screw, completely remove sensor. (Fig 13)
- Next remove the two sensor bracket screws with a 2mm hex wrench and then remove the sensor bracket. (fig 14)
- **When replacing the lower jaw do not loosen or tighten the jam nut on the threaded rod while it is in the mounting block. It will damage the mounting block.**
- Remove the 3/8" hex nut (loosening with a 9/16" wrench, if necessary) and turning Thumb Wheel until the threaded rod comes out of the mounting block.

- Loosen or tighten jam nut with the threaded rod removed. (Fig15) This can be best accomplished by holding the back of the jaw in place with a 3/4" wrench and turning the jam nut with a 9/16" wrench.



Figure 13: Remove Sensor

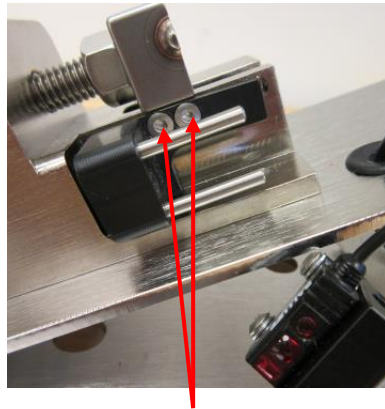

Figure 14: Sensor bracket screws



Figure 15: Threaded rod removed

## 4.0 Troubleshooting

Operating Error	Action
Unit does not operate.	<ol style="list-style-type: none"> <li>1. Check the facility air connection.</li> <li>2. Check all air hose connections and electrical connections on the unit.</li> </ol>
Jaws do not expand.	<ol style="list-style-type: none"> <li>1. Ensure there are no obstructions keeping the jaws from expanding.</li> <li>2. Completely depress the foot pedal to actuate.</li> <li>3. Ensure the toggle switch is set to the appropriate setting (sensor or foot pedal)</li> </ol>
Flexible tubing is splitting/tearing.	<ol style="list-style-type: none"> <li>1. Ensure the tubing being expanded does not exceed the recommended durometer.</li> <li>2. Ensure the lower jaw has been adjusted correctly for the tubing inside diameter (I.D.).</li> <li>3. Verify facility air supply psi or unit pressure adjustment.</li> <li>4. Increase the expansion time setting for a more gradual expansion.</li> </ol>

## 5.0 Maintenance

### 5.1 Periodic Cleaning (annually)

- Wipe down outer surfaces with alcohol, septihol or mild detergents as required.

## 6.0 Product Specifications

Unit Weight	13.5 LBS / 6.1 KG
Overall Dimensions	15-1/4"l x 7"w x 7-1/2"h
Minimum Facility Air Supply	100 PSI
Unit Air Regulator Setting	80-100 PSI

## 7.0 Durometer Scale

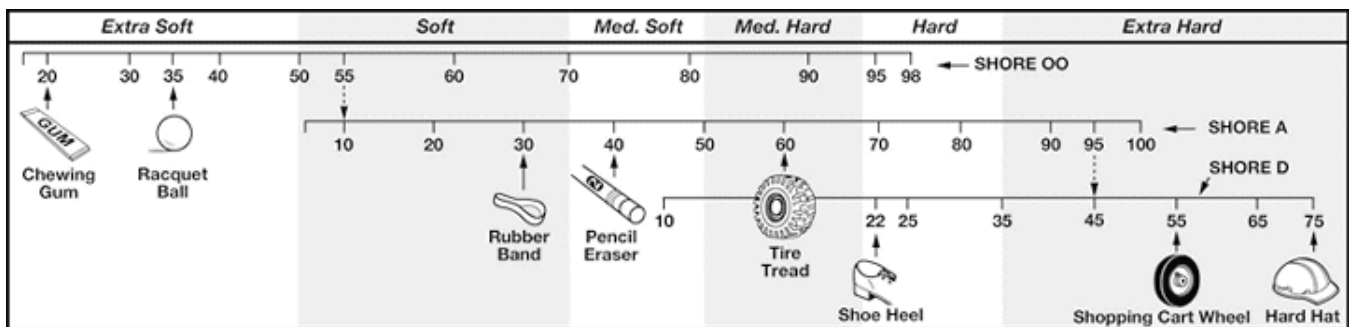

# 8.0 Wiring Diagram

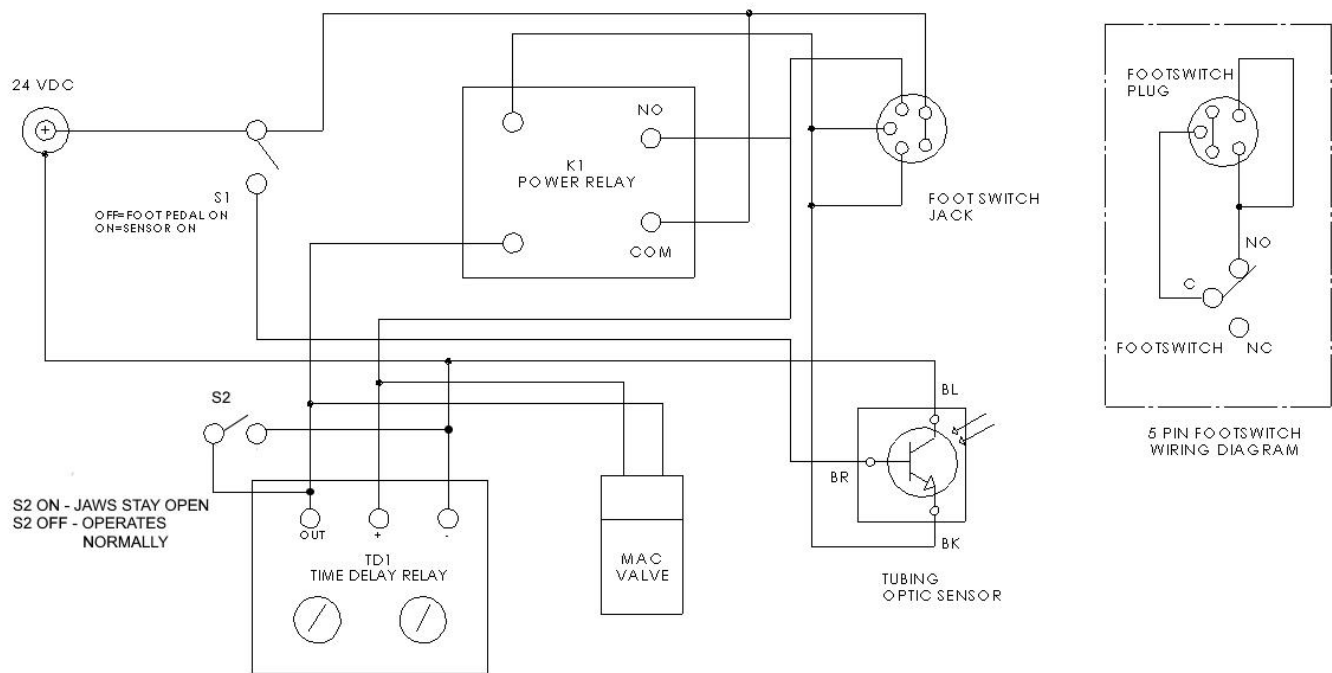

WIRING DIAGRAM  
CRD 222 ATE

## 9.0 Warranty

### 9.1 Warranty

The manufacturer warrants the product manufactured by it, when properly installed, operated, applied and maintained in accordance with the procedures and recommendations outlined in the manufacturer's operation manual, to be free from defects in material or workmanship for a period as specified below, provided such defect is discovered and brought to the manufacturer's attention within the stated warranty period.

The manufacturer will repair or replace any product or part determined to be defective by the manufacturer within the warranty period, provided such defect occurred in the normal service and not as a result of misuse, abuse, neglect or accident. Normal maintenance items requiring routine replacement are not warranted. The warranty covers parts and labor for the warranty period unless otherwise specified. Repair or replacement shall be made at the factory or the installation site, at the sole discretion of the manufacturer. Any service performed on the product by anyone other than the manufacturer must first be authorized by the manufacturer.

Unauthorized service voids the warranty and any resulting charge or subsequent claim will not be paid. Products repaired or replaced under warranty shall be warranted for the unexpired portion of the warranty applying to the original product.

The foregoing is the exclusive remedy of any buyer of the manufacturer's product. The maximum damages liability for the manufacturer is the original purchase price of the product or part.

THE FOREGOING WARRANTY IS EXCLUSIVE AND IN LIEU OF ALL OTHER WARRANTIES, WHETHER WRITTEN, ORAL, OR STATUTORY, AND IS EXPRESSLY IN LIEU OF THE IMPLIED WARRANTY OF MERCHANTABILITY AND THE IMPLIED WARRANTY OF FITNESS FOR A PARTICULAR PURPOSE. THE MANUFACTURER SHALL NOT BE LIABLE FOR LOSS OR DAMAGE BY REASON OF STRICT LIABILITY IN TORT OR ITS NEGLIGENCE IN WHATEVER MANNER INCLUDING DESIGN, MANUFACTURE OR INSPECTION OR THE EQUIPMENT OR ITS FAILURE TO DISCOVER, REPORT, REPAIR, OR MODIFY LATENT DEFECTS INHERENT THEREIN.

THE MANUFACTURER, HIS REPRESENTATIVE OR DISTRIBUTOR SHALL NOT BE LIABLE FOR LOSS OF USE OF THE PRODUCT OR OTHER INCIDENTAL OR CONSEQUENTIAL COSTS, EXPENSES, OR DAMAGES INCURRED BY THE BUYER, WHETHER ARISING FROM BREACH OF WARRANTY, NEGLIGENCE OR STRICT LIABILITY IN TORT.

The manufacturer does not warrant any product, part, material, component, or accessory manufactured by others and sold or supplied in connection with the sale of manufacturer's products.

### 9.1 Warranty Period

Parts and labor are for ninety (90) days from the date of shipment from the factory. Freight to the factory on units that the manufacturer requests to be returned shall be paid by the purchaser, all return freight to be paid by the manufacturer; means of transportation to be specified by the manufacturer.

*For additional information contact: [www.cleanroomdevices.com](http://www.cleanroomdevices.com)*

Clean Room Devices, Inc.  
10855 Dover Street, Suite 100  
Westminster, CO 80021  
303-438-0853