

 **CLEAN ROOM DEVICES, INC.**

CRD120SC TUBING CUTTER

OPERATIONS MANUAL

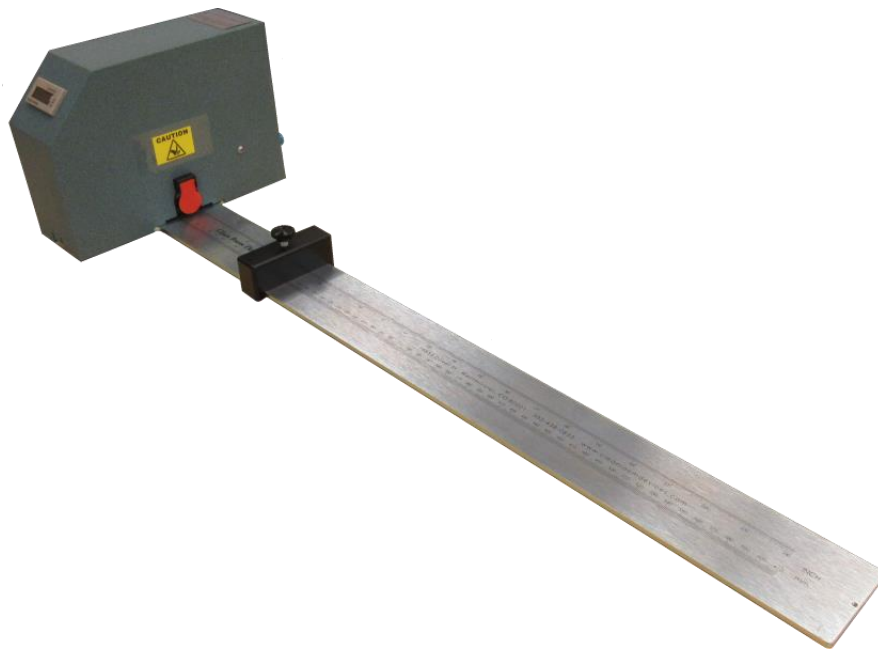

VERSION 2.1
LAST EDITED 05.01.2018
cleanroomdevices.com

Table of Contents

- Table of Contents.....2
- 1.0 General Product & Safety Information.....3
 - 1.1 Product Information
 - 1.2 Safety Information
- 2.0 Installation.....3
 - 2.1 Foot pedal
 - 2.2 Air supply
- 3.0 Operation.....5
 - 3.1 Bushing Installation
 - 3.2 Cutting
- 4.0 Troubleshooting.....6
- 5.0 Maintenance.....7
 - 5.1 Blade Replacement (Chevron blade)
 - 5.2 Blade Replacement (Razor blade)
 - 5.3 Periodic Cleaning (annually)
- 6.0 Product Specifications.....9
- 7.0 Durometer Scale.....9
- 8.0 Parts List.....10
- 9.0 Warranty.....11
 - 9.1 Warranty
 - 9.2 Warranty Period

1.0 General Product & Safety Information

1.1 Product Information

- The CRD120SC Tubing Cutter is designed to cut flexible tubing (including heatshrink) up to a Shore A 100 durometer, including any non-metallic braided materials.
- Easily interchangeable bushings are available. The standard bushings include (12) sizes for the following outside tubing diameters: (1/16", 3/32", 1/8", 5/32", 3/16", 7/32", 1/4", 9/32", 5/16", 3/8", 7/16", 1/2"). Custom sizes are also available.
- The minimum/maximum cut lengths range from 1/16" to 24" long. All lengths within that range can be achieved within plus/minus .030" tolerance utilizing the slide block and scale. Minimum cut lengths of 29/32" can be achieved by visually locating the tube at the end of the bushing and depressing foot pedal.
- Cut lengths down to 1/16" (+/- .002) can be obtained with adjustable stop pin (optional).

1.2 Safety Information

- This product uses an air cylinder to pneumatically actuate a cutting blade internal to the unit. Do not attempt to replace the cutting blade without first disconnecting the air supply.
- **Do not attempt to replace the cutting blade without first disconnecting the air and power supply.**

2.0 Installation

2.1 Foot pedal connection to cover

- From the foot pedal connect the "**BLACK**" 1/4" tube to the "**BLACK**" 1/4" bulkhead connector located on the rear of the cover. Connect the "**CLEAR**" 1/4" tube to the "**WHITE**" 1/4" bulkhead connector located on the rear of the cover. Connect the last "**BLUE**" 1/4" tube to the "**BLUE**" bulkhead connector located on the rear of the cover.
- Figure 2.1.1**



Figure 2.1.1

2.2 Air Supply

- Standard facility compressed air within the range of 100-120 psi is recommended. Lower than 100 psi may affect the “cut” quality. Higher than 120 psi may reduce the life expectancy of internal parts.
- Connect a 1/4” air supply hose to the 1/4” “**GREEN**” bulkhead connector located on the rear of the cover. The air supply should be free of moisture and contaminants. It is recommended that a suitable filter/regulator be installed onto the supply line to preserve the life expectancy of the air valve and associated parts. *Figure 2.1.2*



Figure 2.1.2

3.0 Operation

3.1 Bushing installation

- Install both front and rear bushings appropriate to the outside tube diameter you intend to cut. Use the nearest equivalent if the exact size bushing set is not available (*Note: custom bushing sizes can be made to order by Clean Room Devices, Inc.*).
- To swap out or install new bushings, follow the steps shown below:
- Disconnect the air supply from rear of cover.
- Flip the cutter upside down.
- Loosen the bushing thumb screws and remove bushings from cutter. **Figure 3.1.1**
- Replace with new/different size bushings into the cutter and tighten the thumb screws.

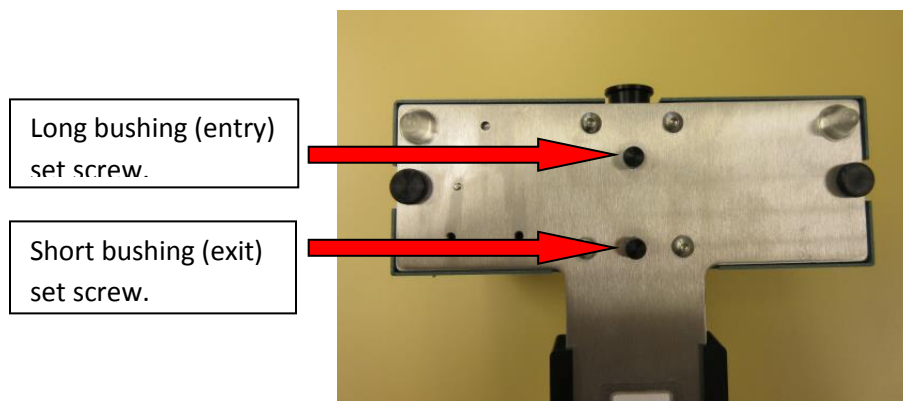

Figure 3.1.1 Bushing thumb screws

3.2 Cutting

- Locate the slide block to the desired cut length using the scale. Secure the slide block in position by rotating the thumb-screw clockwise; take care not to over tighten.
- Insert the tubing end into the bushing towards the direction of the slide block. Once the tubing has cleared the cover continue to pull the tubing through to where it makes contact with the slide block. Then activate the foot switch to cut the tubing. Once cut, remove the tubing front the unit and repeat as needed.

4.0 Troubleshooting

Operating Error	Action
Cutting blade does not actuate.	<ol style="list-style-type: none">1. Check the facility air supply (must have a minimum of 100 psi).2. Ensure front bushing is seated corrected (and flush) against the housing and that the locking screw is tight.
Cutting blade makes bad cuts or leaves burrs.	<ol style="list-style-type: none">1. Ensure the tubing being cut does not exceed the recommended durometer.2. Ensure the proper bushing sizes on both sides have been installed correctly.3. Verify facility air supply is at minimum4. Check the cutting blade for wear or damage and possible replacement.5. Slide block is not tight.
Counter is not functioning properly.	<ol style="list-style-type: none">1. Verify the counter has been reset between batch cuts or production runs.2. Check screws on the counter are secure
Slide block does not move in either direction.	<ol style="list-style-type: none">1. Fully loosen the thumb screw to slide.2. Visually inspect the slide path for dirt or debris.

5.0 Maintenance

5.1 Blade Replacement (Chevron blade)

- Replacement blades can be purchased from *Clean Room Devices, Inc.*
- Ensure air and power supply has been disconnected from the unit prior to removing the cover. Remove the two thumb screws securing the cover to the base plate. Lift cover out of the way. *Figure 5.1.1*
- You now have access to the cutting blade via the replacement window in the knife block housing. Take this opportunity to blow out any debris found within the cutter housing.
- Place a magnetic tip screwdriver (*provided*) on the cutter blade, then remove two (2) mounting screws using a 3mm hex key wrench. (*T-handle preferred*) *Figure 5.1.2*

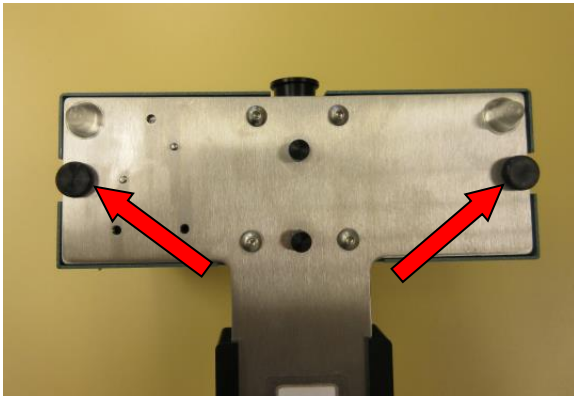

Figure 5.1.1 Cover screws

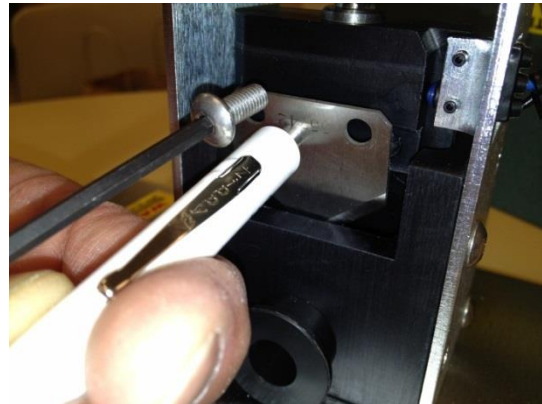

Figure 5.1.2

WARNING

Although the blade may require replacement it remains extremely sharp, handle with care. To avoid injury, proper disposal is highly recommended.

- Install the new knife blade using a magnetic screwdriver and reusing the same screws.
- Re-install the cover and tighten mounting screws and reconnect air supply. Make a few test cuts to verify quality and that the unit is working properly prior to production runs.
- The knife blade screws should be checked periodically for tightness. *Do not over tighten*

5.2 Blade Replacement (Razor blade)

- Replacement blades can be purchased from *Clean Room Devices, Inc.*
- Ensure Air supply has been disconnected from the unit prior to removing the cover. Remove the two (2) button head cap screws securing the cover to the base plate using a 1/8 hex key. Lift cover out of the way.
- You now have access to the cutting blade via the replacement window in the knife block housing. Take this opportunity to blow out any debris found within the cutter housing.
- Place a magnetic tip screwdriver (*provided*) on the cutter blade, then remove two (2) mounting screws using a 3mm hex key wrench. (*T-handle preferred*) *Figure 5.2.1,5.2.2*

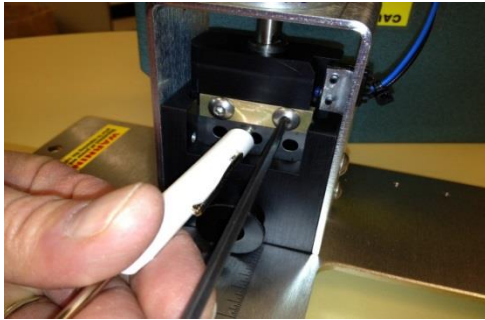

Figure 5.2.1

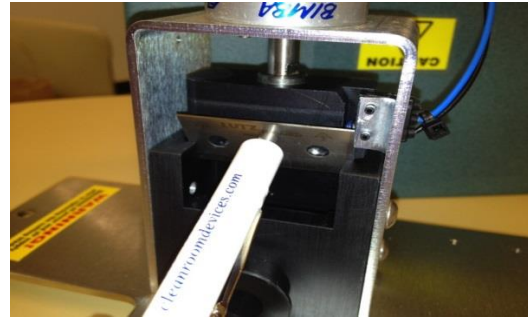

Figure 5.2.2

WARNING

Although the blade may require replacement it remains extremely sharp, handle with care. To avoid injury, proper disposal is highly recommended.

- Note that the back of the blade clamp has a lip. This must be facing toward blade when re-installing to properly hold the blade. *Figure 5.2.3*

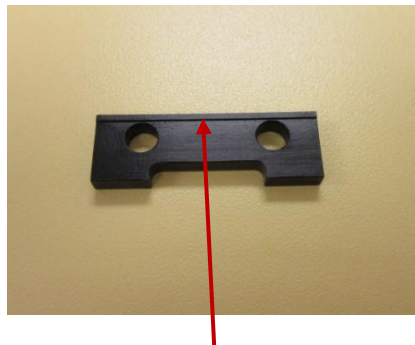

Figure 5.2.3 Showing lip on back (blade) side of clamp

- Install the new knife blade using a magnetic screwdriver reusing the same screws.
- Re-install the cover and tighten mounting screws and reconnect air supply. Make a few test cuts to verify quality and that the unit is working properly prior to production runs.
- The knife blade screws should be checked periodically for tightness. **Do not over tighten.**

5.3 Periodic Cleaning (annually or as needed)

- Wipe down outer surfaces with alcohol, septihol or mild detergents, specifically those surfaces/grooves that come in contact with the slide block.
- Inspect the blade housing cavity (by removing the cover), blow-out any/all debris.

6.0 Product Specifications

Unit Weight	10.0 LBS / 4.54 KG
Overall Dimensions	28" lg. x 9 3/16" w x 6 3/8" ht.
Minimum/Maximum PSI	100 PSI / 120 PSI

7.0 Durometer Scale

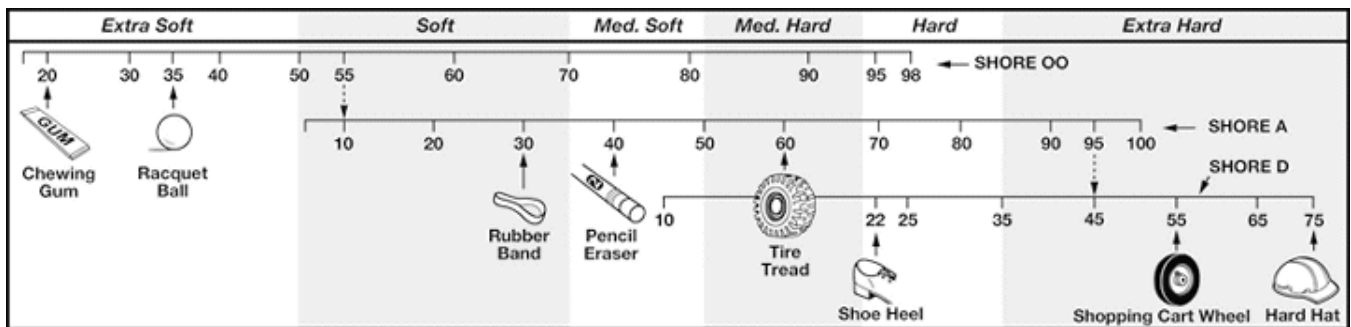

8.0 Parts List

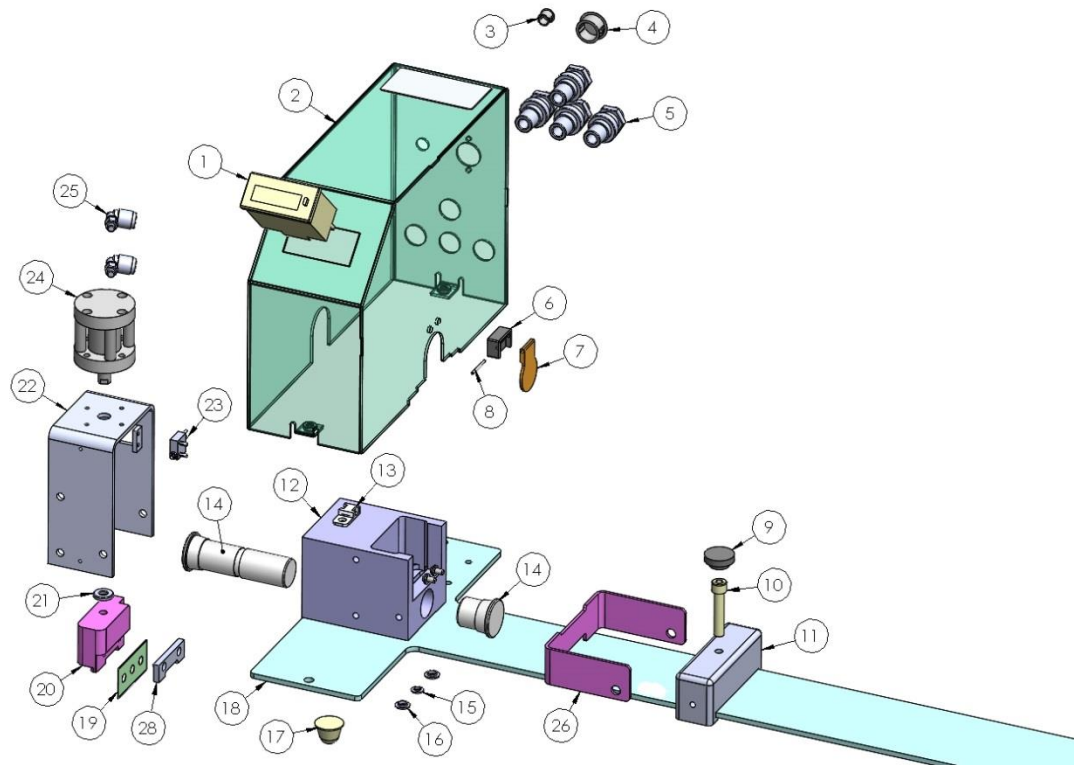

Item	Part Number	Description	Item	Part Number	Description
1	P00001	Counter	14	SCBS###	Bushing Set (Razor)
2	CD120-009	Electronics Cover	15	P00367	Small Shoulder Washer
3	P00355	5/16" Plastic Plug	16	P00368	Large Shoulder Washer
4	P00354	5/8" Plastic Plug	17	P00348	Rubber Foot
5	P00495	1/4" Bulkhead	18	CD120-005	Stainless Steel Base
6	CD100-044	Flapper Mount	19	RB100	Razor Blade
7	CD100-045	Flapper	20	CD001-040	Knife Holder
8	P00435	SS Slotted Spring Pin	21	P00053	Extra Thick #10 Washer
9	P00347	Plastic Screw Head	22	CD120-002	Cylinder Bracket
10	P00346	1/4-20 x 1-1/4" Nylon SHCS	23	P00051	Counter Switch
11	CD130-002	Slide Block	24	P00012	Pneumatic Cylinder
12	CD120-001	Knife Block	25	TS00128	90° Elbow
13	P00109	Cable Tie Mount	26	CD120-021	Rotating Stop Arm

9.0 Warranty

9.1 Warranty

The manufacturer warrants the product manufactured by it, when properly installed, operated, applied and maintained in accordance with the procedures and recommendations outlined in the manufacturer's operation manual, to be free from defects in material or workmanship for a period as specified below, provided such defect is discovered and brought to the manufacturer's attention within the aforesaid warranty period.

The manufacturer will repair or replace any product or part determined to be defective by the manufacturer within the warranty period, provided such defect occurred in the normal service and not as a result of misuse, abuse, neglect or accident. Normal maintenance items requiring routine replacement are not warranted. The warranty covers parts and labor for the warranty period unless otherwise specified. Repair or replacement shall be made at the factory or the installation site, at the sole discretion of the manufacturer. Any service performed on the product by anyone other than the manufacturer must first be authorized by the manufacturer.

Unauthorized service voids the warranty and any resulting charge or subsequent claim will not be paid. Products repaired or replaced under warranty shall be warranted for the unexpired portion of the warranty applying to the original product.

The foregoing is the exclusive remedy of any buyer of the manufacturer's product. The maximum damages liability for the manufacturer is the original purchase price of the product or part.

THE FORGOING WARRANTY IS EXCLUSIVE AND IN LIEU OF ALL OTHER WARRANTIES, WHETHER WRITTEN, ORAL, OR STATUTORY, AND IS EXPRESSLY IN LIEU OF THE IMPLIED WARRANTY OF MERCHANTABILITY AND THE IMPLIED WARRANTY OF FITNESS FOR A PARTICULAR PURPOSE. THE MANUFACTURER SHALL NOT BE LIABLE FOR LOSS OR DAMAGE BY REASON OF STRICT LIABILITY IN TORT OR ITS NEGLIGENCE IN WHATEVER MANNER INCLUDING DESIGN, MANUFACTURE OR INSPECTION OR THE EQUIPMENT OR ITS FAILURE TO DISCOVER, REPORT, REPAIR, OR MODIFY LATENT DEFECTS INHERENT THEREIN.

THE MANUFACTURER, HIS REPRESENTATIVE OR DISTRIBUTOR SHALL NOT BE LIABLE FOR LOSS OF USE OF THE PRODUCT OR OTHER INCIDENTAL OR CONSEQUENTIAL COSTS, EXPENSES, OR DAMAGES INCURRED BY THE BUYER, WHETHER ARISING FROM BREACH OF WARRANTY, NEGLIGENCE OR STRICT LIABILITY IN TORT.

The manufacturer does not warrant any product, part, material, component, or accessory manufactured by others and sold or supplied in connection with the sale or manufacturer's products.

9.2 Warranty Period

Parts and labor are for ninety (90) days from the date of shipment from the factory. Freight to the factory on units that the manufacturer requests to be returned shall be paid by the purchaser, all return freight to be paid by the manufacturer; means of transportation to be specified by the manufacturer.

*For additional information contact: www.cleanroomdevices.com
Clean Room Devices, Inc.
10855 Dover Street, Suite 100
Westminster, CO 80021
303-438-0853*